

GARMIN®



EDGE® 840

Owner's Manual

© 2023 Garmin Ltd. or its subsidiaries

All rights reserved. Under the copyright laws, this manual may not be copied, in whole or in part, without the written consent of Garmin. Garmin reserves the right to change or improve its products and to make changes in the content of this manual without obligation to notify any person or organization of such changes or improvements. Go to www.garmin.com for current updates and supplemental information concerning the use of this product.

Garmin®, the Garmin logo, ANT+®, Auto Lap®, Auto Pause®, Edge®, Forerunner®, inReach®, and Virtual Partner® are trademarks of Garmin Ltd. or its subsidiaries, registered in the USA and other countries. Connect IQ™, Firstbeat Analytics™, Garmin Connect™, Garmin Express™, Garmin Index™, HRM-Dual™, HRM-Run™, Rally™, Varia™, and Vector™ are trademarks of Garmin Ltd. or its subsidiaries. These trademarks may not be used without the express permission of Garmin.

Android™ is a trademark of Google Inc. Apple® and Mac® are trademarks of Apple, Inc., registered in the U.S. and other countries. The BLUETOOTH® word mark and logos are owned by the Bluetooth SIG, Inc. and any use of such marks by Garmin is under license. The Cooper Institute®, as well as any related trademarks, are the property of The Cooper Institute. Di2™ and Shimano STEPS™ are trademarks of Shimano, Inc. Shimano® is a registered trademark of Shimano, Inc. Training Stress Score™ (TSS), Intensity Factor™ (IF), and Normalized Power™ (NP) are trademarks of Peaksware, LLC. STRAVA and Strava™ are trademarks of Strava, Inc. Wi-Fi® is a registered trademark of Wi-Fi Alliance Corporation. Windows® and Windows NT® are registered trademarks of Microsoft Corporation in the United States and other countries. Other trademarks and trade names are those of their respective owners.

This product is ANT+® certified. Visit www.thisisant.com/directory for a list of compatible products and apps.

M/N: A04394

Table of Contents

Introduction.....	1	Training Indoors.....	10
Device Overview.....	1	Using an Indoor Trainer.....	10
Viewing Widgets.....	2	Setting Resistance.....	11
Viewing Glances.....	2	Setting Target Power.....	11
Using the Touchscreen.....	2	Interval Workouts.....	11
Locking the Touchscreen.....	2	Creating an Interval Workout.....	11
Training.....	3	Starting an Interval Workout.....	11
Going for a Ride.....	3	Racing a Previous Activity.....	12
Evaluating an Activity.....	3	Training for a Race Event.....	12
Unified Training Status.....	4	Race Calendar and Primary Event....	12
Training Plans.....	4	Setting a Training Target.....	13
Using Garmin Connect Training		My Stats.....	13
Plans.....	4	Performance Measurements.....	13
Viewing the Training Calendar.....	4	Training Status Levels.....	14
Power Guide.....	5	Tips for Getting Your Training	
Creating a Power Guide.....	5	Status.....	14
Starting a Power Guide.....	5	About VO2 Max. Estimates.....	14
Workouts.....	6	Getting Your VO2 Max. Estimate..	15
Creating a Workout.....	6	Tips for Cycling VO2 Max.	
Repeating Workout Steps.....	6	Estimates.....	16
Editing a Workout.....	6	Heat and Altitude Performance	
Creating a Custom Workout on Garmin		Acclimation.....	16
Connect.....	7	Acute Load.....	16
Following a Workout From Garmin		Viewing Your Acute Load.....	16
Connect.....	7	Training Load Focus.....	17
Daily Suggested Workouts.....	7	Viewing Cycling Ability.....	17
Following a Daily Suggested		About Training Effect.....	18
Workout.....	7	Recovery Time.....	18
Turning Daily Suggested Workout		Viewing Your Recovery Time.....	19
Prompts On and Off.....	7	Getting Your Exercise Load	
Starting a Workout.....	7	Estimate.....	19
Stopping a Workout.....	8	Getting Your FTP Estimate.....	20
Deleting Workouts.....	8	Conducting an FTP Test.....	20
Segments.....	8	Automatically Calculating FTP.....	21
Strava™ Segments.....	8	Viewing Your Real-Time Stamina....	22
Using the Strava Segment Explore		Viewing Your Stress Score.....	23
Widget.....	8	Viewing Your Power Curve.....	23
Following a Segment from Garmin		Syncing Activities and Performance	
Connect.....	9	Measurements.....	23
Enabling Segments.....	9	Turning Off Performance	
Racing a Segment.....	9	Notifications.....	23
Viewing Segment Details.....	10	Pausing Your Training Status.....	23
Segment Options.....	10	Resuming Your Paused Training	
Deleting a Segment.....	10	Status.....	24
		Viewing Your Fitness Age.....	24
		Viewing Intensity Minutes.....	24

Personal Records.....	24	Assistance.....	35
Viewing Your Personal Records.....	24	Adding Emergency Contacts.....	36
Reverting a Personal Record.....	24	Viewing Your Emergency	
Deleting a Personal Record.....	24	Contacts.....	36
Training Zones.....	25	Requesting Assistance.....	36
Navigation.....	25	Turning Incident Detection On and	
Locations.....	25	Off.....	36
Marking Your Location.....	25	Cancelling an Automated	
Saving Locations from the Map.....	25	Message.....	36
Navigating to a Location.....	26	Sending a Status Update After an	
Navigating Back to Start.....	26	Incident.....	36
Stopping Navigation.....	26	Turning On LiveTrack.....	37
Editing Locations.....	27	Starting a GroupTrack Session.....	37
Deleting a Location.....	27	Live Event Sharing.....	38
Courses.....	27	Spectator Messaging.....	38
Planning and Riding a Course.....	27	Setting the Bike Alarm.....	38
Creating and Riding a Round-Trip		Playing Audio Prompts on Your	
Course.....	28	Phone.....	39
Creating a Course from a Recent		Listening to Music.....	39
Ride.....	28	Wi-Fi Connectivity Features.....	39
Following a Course From Garmin		Setting Up Wi-Fi Connectivity.....	39
Connect.....	29	Wi-Fi Settings.....	39
Tips for Riding a Course.....	29	Wireless Sensors.....	40
Viewing Course Details.....	29	Putting On the Heart Rate Monitor.....	41
Displaying a Course on the Map... 30		Setting Your Heart Rate Zones.....	42
Course Options.....	30	About Heart Rate Zones.....	42
Rerouting a Course.....	30	Fitness Goals.....	42
Stopping a Course.....	30	Tips for Erratic Heart Rate Data.....	42
Deleting a Course.....	30	Installing the Speed Sensor.....	43
Trailforks Routes.....	30	Installing the Cadence Sensor.....	44
Using ClimbPro.....	31	About the Speed and Cadence	
Using the Climb Explore Widget.....	31	Sensors.....	44
Climb Categories.....	32	Data Averaging for Cadence or	
Map Settings.....	32	Power.....	44
Map Appearance Settings.....	32	Pairing Your Wireless Sensors.....	45
Changing the Map Orientation.....	32	Wireless Sensor Battery Life.....	45
Map Themes.....	33	Training with Power Meters.....	45
Route Settings.....	33	Setting Your Power Zones.....	45
Selecting an Activity for Route		Calibrating Your Power Meter.....	46
Calculation.....	33	Pedal-Based Power.....	46
Connected Features.....	33	Cycling Dynamics.....	46
Pairing Your Phone.....	34	Using Cycling Dynamics.....	47
Bluetooth Connected Features.....	34	Updating the Rally System Software	
Safety and Tracking Features.....	35	Using the Edge Bike Computer.....	47
Incident Detection.....	35	Situational Awareness.....	48
		Using the Varia Camera Controls.....	48

Enabling the Green Threat Level Tone.....	48	Marking Laps by Time.....	57
Using Electronic Shifters.....	48	Customizing the Lap Banner.....	57
The Edge 840 Bike Computer and Your eBike.....	48	Using Auto Sleep.....	57
Viewing eBike Sensor Details.....	48	Using Auto Pause.....	57
inReach Remote.....	49	Using Auto Scroll.....	58
Using the inReach Remote.....	49	Starting the Timer Automatically.....	58
History.....	49	Changing the Satellite Setting.....	58
Viewing Your Ride.....	49	Phone Settings.....	58
Viewing Your Time in Each Training Zone.....	49	System Settings.....	58
Deleting a Ride.....	49	Display Settings.....	59
Viewing Data Totals.....	50	Using the Backlight.....	59
Deleting Data Totals.....	50	Customizing the Glances.....	59
Garmin Connect.....	50	Customizing the Widget Loop.....	59
Sending Your Ride to Garmin Connect.....	50	Data Recording Settings.....	59
Data Recording.....	51	Changing the Units of Measure.....	59
Data Management.....	51	Turning the Device Tones On and Off.....	60
Connecting the Device to Your Computer.....	51	Changing the Device Language.....	60
Transferring Files to Your Device.....	51	Time Zones.....	60
Deleting Files.....	51	Setting Up Extended Display Mode.....	60
Disconnecting the USB Cable.....	52	Exiting Extended Display Mode.....	60
Customizing Your Device.....	52	Device Information.....	61
Connect IQ Downloadable Features....	52	Charging the Device.....	61
Downloading Connect IQ Features Using Your Computer.....	52	About the Battery.....	61
Profiles.....	52	Installing the Standard Mount.....	62
Setting Up Your User Profile.....	52	Installing the Out-Front Mount.....	63
Gender Settings.....	53	Releasing the Edge.....	63
Training Settings.....	53	Installing the Mountain Bike Mount....	64
Updating Your Activity Profile.....	53	Product Updates.....	65
Adding a Data Screen.....	54	Updating the Software Using the Garmin Connect App.....	65
Editing a Data Screen.....	54	Updating the Software Using Garmin Express.....	65
Rearranging Data Screens.....	54	Specifications.....	66
Alerts and Prompts Settings.....	55	Edge Specifications.....	66
Setting Range Alerts.....	55	HRM-Dual Specifications.....	66
Setting Recurring Alerts.....	55	Speed Sensor 2 and Cadence Sensor 2 Specifications.....	66
Setting Smart Eat and Drink Alerts.....	56	Viewing Device Information.....	66
Auto Lap.....	56	Viewing Regulatory and Compliance Information.....	66
Marking Laps by Position.....	56	Device Care.....	67
Marking Laps by Distance.....	56	Cleaning the Device.....	67
		Caring for the Heart Rate Monitor....	67
		User Replaceable Batteries.....	67
		Replacing the HRM-Dual Battery.....	68

Replacing the Speed Sensor Battery.....	69
Replacing the Cadence Sensor Battery.....	70
Replacing the Cadence Sensor Battery.....	71

Troubleshooting..... 71

Resetting the Device.....	71
Restoring the Default Settings.....	71
Clearing User Data and Settings.....	71
Maximizing Battery Life.....	72
Turning On Battery Saver Mode.....	72
My phone will not connect to the device.....	72
Tips for Using the Edge 840 Solar Bike Computer.....	73
Improving GPS Satellite Reception.....	73
My device is in the wrong language.....	73
Setting Your Elevation.....	73
Temperature Readings.....	73
Calibrating the Barometric Altimeter...	74
Calibrating the Compass.....	74
Replacement O-rings.....	74
Getting More Information.....	74

Appendix..... 75

Data Fields.....	75
VO2 Max. Standard Ratings.....	83
FTP Ratings.....	83
Heart Rate Zone Calculations.....	84
Wheel Size and Circumference.....	84

Introduction







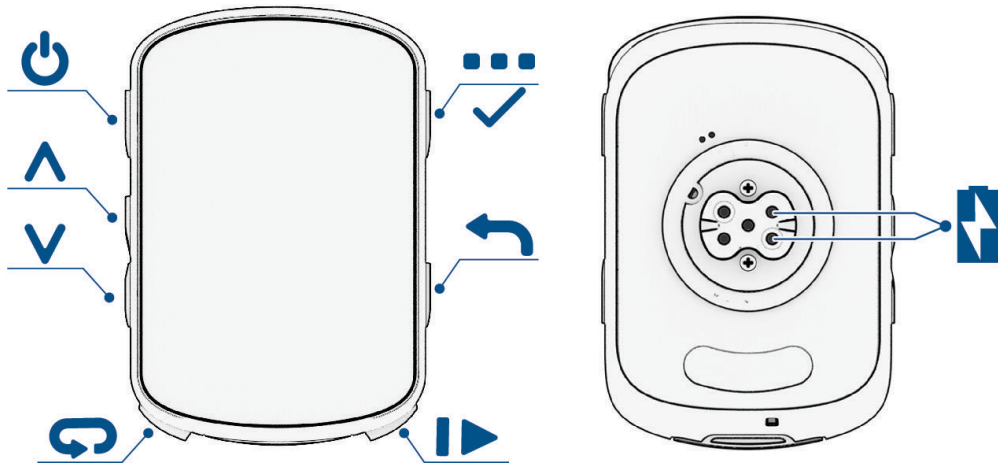

⚠ WARNING

See the *Important Safety and Product Information* guide in the product box for product warnings and other important information.

Always consult your physician before you begin or modify any exercise program.

Device Overview



	Press to enter sleep mode and wake the device. Hold to turn the device on and off and lock the touchscreen.
	Press to scroll through the data screens, options, and settings. From the home screen, press to view the status page.
	Press to scroll through the data screens, options, and settings. From the home screen, press to view glances.
	Press to mark a new lap.
	Press to start and stop the activity timer.
	Press to return to the previous screen. Hold to return to the home screen.
	Hold to open the main menu. Press to select.
	Charge using an external power accessory.

NOTE: Go to buy.garmin.com to purchase optional accessories.

Viewing Widgets

Your device is preloaded with several widgets, and more are available when you pair your device with a phone or other compatible device.

- 1 From the home screen, swipe down from the top of the screen.

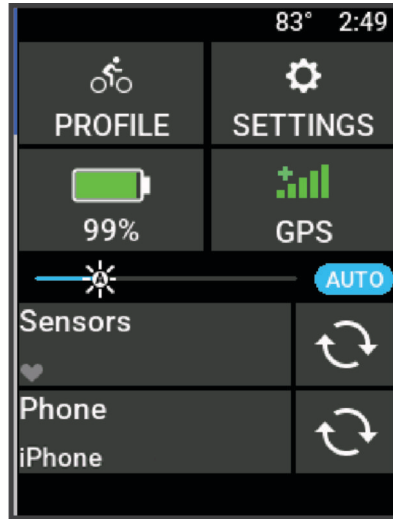

The settings widget appears. A flashing icon means the device is searching for a signal. A solid icon means the signal was found or the sensor is connected. You can select any icon to change the settings.

- 2 Swipe left or right to view more widgets.









The next time you swipe down to view the widgets, the last widget you viewed appears.

Viewing Glances

Glances provide quick access to health data, activity information, built-in sensors, and more.



- From the home screen, swipe up.
The device scrolls through the glances.
- Select a glance to view additional information.
- Select  to customize the glances (*Customizing the Glances*, page 59).

Using the Touchscreen

- When the timer is running, tap the screen to view the timer overlay.
The timer overlay allows you to return to the home screen during a ride.
- Select  to return to the home screen.
- Swipe or select the arrows to scroll.
- Select  to open a menu.
- Select  to return to the previous page.
- Select  to save your changes and close the page.
- Select  to close the page and return to the previous page.
- Select  to search near a location.
- Select  to delete an item.
- Select  for more information.

Locking the Touchscreen





You can lock the screen to prevent inadvertent screen touches.

- Hold , and select **Lock Screen**.
- During an activity, select .

Training



Going for a Ride

If you are using a wireless sensor or accessory, it can be paired and activated during initial setup ([Pairing Your Wireless Sensors, page 45](#)).

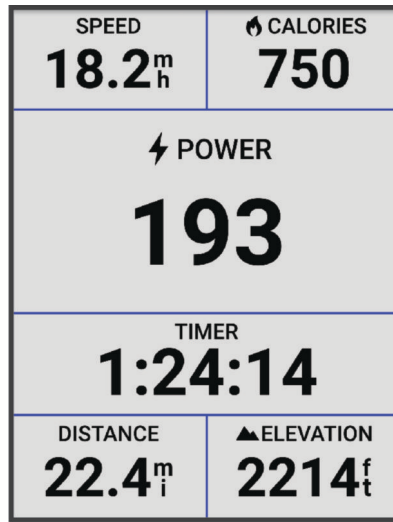
- 1 Hold  to turn on the device.
- 2 Go outside, and wait while the device locates satellites.
The satellite bars turn green when the device is ready.
- 3 From the home screen, select  or  to change the biking profile.
- 4 Press  to start the activity timer.





NOTE: History is recorded only while the activity timer is running.

- 5 Swipe left or right to view additional data screens.
You can swipe down from the top of the data screens to view the widgets.
- 6 If necessary, tap the screen to view status overlay data (including battery life) or return to the home screen.
- 7 Press  to stop the activity timer.
TIP: Before you save this ride and share it on your Garmin Connect™ account, you can change the ride type. Accurate ride type data is important for creating bike friendly courses.
- 8 Select **Save**.
- 9 Select .

Evaluating an Activity

You can customize the self-evaluation setting for your activity profiles ([Training Settings, page 53](#)).

- 1 After you complete an activity, select **Save**.
- 2 Select  or  to choose a number that corresponds with your perceived effort.

NOTE: You can select Skip to skip the self evaluation.

- 3 Select how you felt during the activity.
- 4 Select **Accept**.

You can view evaluations in the Garmin Connect app.

Unified Training Status

When you use more than one Garmin® device with your Garmin Connect account, you can choose which device is the primary data source for everyday use and for training purposes.

From the Garmin Connect app menu, select Settings.

Primary Training Device: Sets the priority data source for training metrics like your training status and load focus.

Primary Wearable: Sets the priority data source for daily health metrics like steps and sleep. This should be the watch you wear most often.



TIP: For the most accurate results, Garmin recommends that you sync often with your Garmin Connect account.

Training Plans

You can set up a training plan in your Garmin Connect account and send the training plan workouts to your device. All scheduled workouts sent to the device appear in the training calendar.

Using Garmin Connect Training Plans

Before you can download and use a training plan, you must have a Garmin Connect account ([Garmin Connect, page 50](#)), and you must pair the Edge device with a compatible phone.

- 1 From the Garmin Connect app, select  or .
- 2 Select **Training & Planning > Training Plans**.
- 3 Select and schedule a training plan.
- 4 Follow the on-screen instructions.
- 5 Review the training plan in your calendar.

Viewing the Training Calendar

When you select a day in the training calendar, you can view or start the workout. You can also view saved rides.

- 1 Select **Training > Training Plan**.
- 2 Select .
- 3 Select a day to view a scheduled workout or a saved ride.

Power Guide

You can create and use a power strategy to plan your effort on a course. Your Edge device uses your FTP, the course elevation, and the projected time it will take you to complete the course to create a customized power guide.

One of the most important steps in planning a successful power guide strategy is choosing your effort level. Putting a harder effort into the course will increase the power recommendations, while choosing an easier effort will reduce them ([Creating a Power Guide, page 5](#)). The primary goal of a power guide is to help you complete the course based on what is known about your ability, not to achieve a specific target time. You can adjust the effort level during your ride.

Power guides are always associated with a course and cannot be used with workouts or segments. You can view and edit your strategy in Garmin Connect and sync it with compatible Garmin devices. This feature requires a power meter, which must be paired with your device ([Pairing Your Wireless Sensors, page 45](#)). After the devices are paired, you can customize the optional data fields ([Data Fields, page 75](#)).

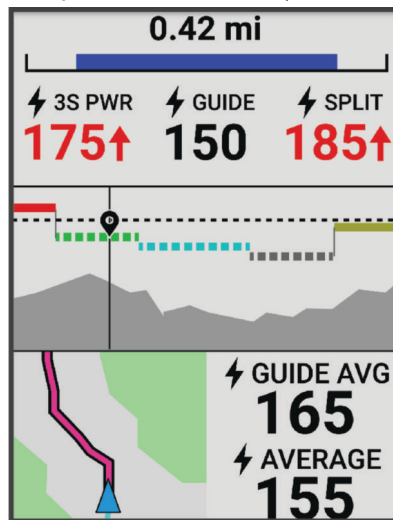

Creating a Power Guide

Before you can create a power guide, you must pair a power meter with your device ([Pairing Your Wireless Sensors, page 45](#)).

- 1 Select **Training** > **Power Guide** > **+**.
- 2 Select an option:
 - Select **Use Saved Course** to use a saved course, and select the course.
 - Select **Course Creator** to create a new course, and select **⋮** > **Create Power Guide**.
- 3 Enter a name for the power guide, and select **✓**.
- 4 Select a riding position.
- 5 Select a gear weight.
- 6 Select **Save**.

Starting a Power Guide

Before you can start a power guide, you must create a power guide ([Creating a Power Guide, page 5](#)).

- 1 Select **Training** > **Power Guide**.
- 2 Select a power guide.
- 3 Select **Ride**.
- 4 Press **▶** to start the activity timer.

Workouts

You can create custom workouts that include goals for each workout step and for varied distances, times, and calories. You can create workouts using Garmin Connect, and transfer them to your device. You can also create and save a workout directly on your device.

You can schedule workouts using Garmin Connect. You can plan workouts in advance and store them on your device.

Creating a Workout

- 1 Select **Training** > **Workouts** > **+**.
- 2 Select **:** > **Rename**, enter a workout name, and select **✓** (optional).
- 3 Select **Add New Step**.
- 4 Select the type of workout step.
For example, select Rest to use the step as a rest lap.
During a rest lap, the activity timer continues to run and data is recorded.
- 5 Select the workout step duration.
For example, select Distance to end the step after a specific distance.
- 6 If necessary, enter a custom value for the duration.
- 7 Select the workout step target type.
For example, select Heart Rate Zone to maintain a consistent heart rate during the step.
- 8 If necessary, select a target zone or enter a custom range.
For example, you can select a heart rate zone. Each time you exceed or drop below the specified heart rate, the device beeps and displays a message.
NOTE: You can also select a secondary target. For example, you can ride for five minutes in a power zone as your primary target, with a cadence rate as your secondary target.
- 9 Select **✓** to save the step.
- 10 Select **Add New Step** to add additional steps to the workout.
- 11 Select **Add New Step** > **Repeat** > **✓** to repeat a step.
- 12 Select **✓** to save the workout.

Repeating Workout Steps

Before you can repeat a workout step, you must create a workout with at least one step.



- 1 Select **Add New Step**.
- 2 Select an option:
 - Select **Repeat** to repeat a step one or more times. For example, you can repeat a 5-mile step ten times.
 - Select **Repeat Until** to repeat a step for a specific duration. For example, you can repeat a 5-mile step for 60 minutes or until your heart rate reaches 160 bpm.
- 3 Select **Back To Step**, and select a step to repeat.
- 4 Select **✓** to save the step.

Editing a Workout

- 1 Select **Training** > **Workouts**.
- 2 Select a workout.
- 3 Select **✎**.
- 4 Select a step.
- 5 Change the step attributes, and select **✓**.
- 6 If necessary, select **:** > **Delete** > **✓** to delete the step.
- 7 Select **✓** to save the workout.

Creating a Custom Workout on Garmin Connect

Before you can create a workout on the Garmin Connect app, you must have a Garmin Connect account ([Garmin Connect, page 50](#)).

- 1 From the Garmin Connect app, select  or .
- 2 Select **Training & Planning > Workouts > Create a Workout**.
- 3 Select an activity.
- 4 Create your custom workout.
- 5 Select **Save**.
- 6 Enter a name for your workout, and select **Save**.

The new workout appears in your list of workouts.

NOTE: You can send this workout to your device ([Following a Workout From Garmin Connect, page 7](#)).

Following a Workout From Garmin Connect

Before you can download a workout from Garmin Connect, you must have a Garmin Connect account ([Garmin Connect, page 50](#)).

- 1 Select an option:
 - Open the Garmin Connect app.
 - Go to connect.garmin.com.
- 2 Select **Training & Planning > Workouts**.
- 3 Find a workout, or create and save a new workout.
- 4 Select  or **Send to Device**.
- 5 Follow the on-screen instructions.

Daily Suggested Workouts

Daily suggested workouts are recommended based on your previous activities saved to your Garmin Connect account. When you are training for a race event, your daily suggested workouts appear in your training calendar ([Viewing the Training Calendar, page 4](#)) and adapt to your upcoming race ([Training for a Race Event, page 12](#)).

NOTE: You must ride with heart rate and power for one week to get workout recommendations.

Following a Daily Suggested Workout

You must ride with heart rate and power for one week to get workout recommendations.

- 1 Select **Training > Workouts > Daily Suggested Workout**.
- 2 Select **Ride**.

Turning Daily Suggested Workout Prompts On and Off







- 1 Select **Training > Workouts > Daily Suggested Workout > **.
- 2 Select **Show on Home Screen**.

Starting a Workout



- 1 Select **Training > Workouts**.
- 2 Select a workout.
- 3 Select **Ride**.
- 4 Press  to start the activity timer.

After you begin a workout, the device displays each step of the workout, the target (if any), and current workout data. An audible alarm sounds when you are about to finish a workout step. A message appears, counting down the time or distance until a new step begins.

Stopping a Workout

- At any time, press  to end a workout step and begin the next step.
- From the workout screen, swipe up from the bottom of the screen, and select an option:
 - Select  to pause the current workout step.
 - Select  to end a workout step and repeat the previous step.
 - Select  to end a workout step and begin the next step.
- At any time, press  to stop the activity timer.
- At any time, swipe down from the top of the screen, and on the controls widget, select **Stop Workout** >  to end the workout.

Deleting Workouts

- 1 Select **Training** > **Workouts** >  > **Delete Multiple**.
- 2 Select one or more workouts.
- 3 Select .

Segments

Following a segment: You can send segments from your Garmin Connect account to your device. After a segment is saved to your device, you can follow the segment.

NOTE: When you download a course from your Garmin Connect account, all segments in the course are downloaded automatically.

Racing a segment: You can race a segment, trying to match or exceed your personal record or other cyclists who have ridden the segment.

Strava™ Segments



You can download Strava segments to your Edge 840 device. Follow Strava segments to compare your performance with your past rides, friends, and pros who have ridden the same segment.

To sign up for a Strava membership, go to the segments menu in your Garmin Connect account. For more information, go to www.strava.com.

The information in this manual applies to both Garmin Connect segments and Strava segments.

Using the Strava Segment Explore Widget

The Strava Segment Explore widget allows you to view and ride nearby Strava segments.

- 1 From the Strava Segment Explore widget, select a segment.
- 2 Select an option:
 - Select  to star the segment in your Strava account.
 - Select **Download** > **Ride** to download a segment to your device and ride it.
 - Select **Ride** to ride a downloaded segment.
- 3 Select  or  to view your segment times, the best times of your friends, and the time of the segment leader.

Following a Segment from Garmin Connect

Before you can download and follow a segment from Garmin Connect, you must have a Garmin Connect account ([Garmin Connect, page 50](#)).

NOTE: If you are using Strava segments, your starred segments are transferred automatically to your device when it syncs with the Garmin Connect app.

- 1 Select an option:
 - Open the Garmin Connect app.
 - Go to connect.garmin.com.
- 2 Select a segment.
- 3 Select  or **Send to Device**.
- 4 Follow the on-screen instructions.
- 5 On the Edge bike computer, select **Training > Segments**.
- 6 Select the segment.
- 7 Select **Ride**.

Enabling Segments

You can choose which segments currently loaded on the device are enabled.

- 1 Select **Training > Segments > Segment Options > Enable/Disable > Edit Multiple**.
- 2 Select the segments to enable.

Racing a Segment

Segments are virtual race courses. You can race a segment, and compare your performance to past activities, other riders' performance, connections in your Garmin Connect account, or other members of the cycling community. You can upload your activity data to your Garmin Connect account to view your segment position.

NOTE: If your Garmin Connect account and Strava account are linked, your activity is automatically sent to your Strava account so you can review the segment position.

- 1 Press  to start the activity timer, and go for a ride.

When your path crosses an enabled segment, you can race the segment.
- 2 Start racing the segment.

The segment data screen appears automatically.

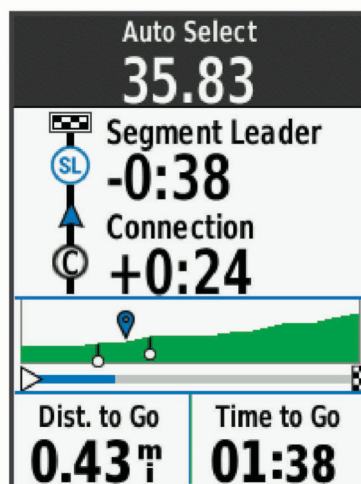

- 3 If necessary, use the arrows to change your goal during your race.

You can race against the segment leader, your past performance, or other riders (if applicable). The goal automatically adjusts based on your current performance.
- A message appears when the segment is complete.

Viewing Segment Details

- 1 Select **Training** > **Segments**.
- 2 Select a segment.
- 3 Select an option:
 - Select **Map** to view the segment on the map.
 - Select **Elevation** to view an elevation plot of the segment.
 - Select **Leaderboard** to view the ride times and average speeds for the segment leader, group leader or challenger, your personal best time and average speed, and other riders (if applicable).
TIP: You can select a leaderboard entry to change your segment race goal.
 - Select **Enable** to enable segment racing and prompts that alert you to approaching segments.

Segment Options

Select **Training** > **Segments** > **Segment Options**.

Turn Guidance: Enables or disables turn prompts.

Auto Select Effort: Enables or disables automatic goal adjustment based on your current performance.



Search: Allows you to search for saved segments by name.

Enable/Disable: Enables or disables the segments currently loaded on the device.

Default Leader Priority: Allows you to select the order for goal targets while racing a segment.

Delete: Allows you to delete all or multiple saved segments from the device.

Deleting a Segment

- 1 Select **Training** > **Segments**.
- 2 Select a segment.
- 3 Select  > .

Training Indoors

The device includes an indoor activity profile where GPS is turned off. When GPS is turned off, speed and distance are not available unless you have a compatible sensor or indoor trainer that sends speed and distance data to the device.

Using an Indoor Trainer





Before you can use a compatible indoor trainer, you must pair the trainer with your device using ANT+® technology ([Pairing Your Wireless Sensors, page 45](#)).

You can use your device with an indoor trainer to simulate resistance while following a course, activity, or workout. While using an indoor trainer, GPS is turned off automatically.



- 1 Select **Training** > **Smart Trainer**.
- 2 Select an option:
 - Select **Free Ride** to manually adjust the resistance level.
 - Select **Follow a Course** to follow a saved course ([Courses, page 27](#)).
 - Select **Follow an Activity** to follow a saved ride ([Going for a Ride, page 3](#)).
 - Select **Follow a Workout** to follow a saved workout ([Workouts, page 6](#)).

NOTE: The trainer resistance changes based on the course or ride information. Some compatible trainers allow you to set the grade and target power.
- 3 Select a course, activity, or workout.
- 4 Select **Ride**.
- 5 Press  to start the activity timer.

Setting Resistance

- 1 Select **Training** > **Smart Trainer** > **Set Resistance**.
- 2 Select  or  to set the resistance force applied by the trainer.
- 3 Press  to start the activity timer.
- 4 If necessary, select  or  to adjust the resistance during your activity.





Setting Target Power

- 1 Select **Training** > **Smart Trainer** > **Set Target Power**.
- 2 Set the target power value.
- 3 Press  to start the activity timer.
The resistance force applied by the trainer is adjusted to maintain a constant power output based on your speed.
- 4 If necessary, select  or  to adjust the target power during your activity.



Interval Workouts

You can create interval workouts based on distance or time. The device saves your custom interval workout until you create another interval workout. You can use open intervals when you are riding a known distance. When you press , the device records an interval and moves to a rest interval.

Creating an Interval Workout

- 1 Select **Training** > **Intervals** >  > **Intervals** > **Target Type**.
- 2 Select an option.
TIP: You can create an open-ended interval by setting the type to Open.
- 3 If necessary, enter a high and low value for the interval.
- 4 Select **Duration**, enter a time interval value, and select .
- 5 Select .
- 6 Select **Rest** > **Target Type**.
- 7 Select an option.
- 8 If necessary, enter a high and low value for the rest interval.
- 9 Select **Duration**, enter time value for the rest interval, and select .
- 10 Select .
- 11 Select one or more options:
 - To set the number of repetitions, select **Repeat**.
 - To add an open-ended warm up to your workout, select **Warm Up** > **On**.
 - To add an open-ended cool down to your workout, select **Cool Down** > **On**.

Starting an Interval Workout

- 1 Select **Training** > **Intervals** > **Do Workout**.
- 2 Press  to start the activity timer.
- 3 When your interval workout has a warm up, press  to begin the first interval.
- 4 Follow the on-screen instructions.

When you complete all of the intervals, a message appears.

Racing a Previous Activity

You can race a previously recorded activity or saved course.

- 1 Select **Training** > **Race an Activity**.
- 2 Select an option:
 - Select **Ride History**.
 - Select **Saved Courses**.
- 3 Select the activity or course.
- 4 Select **Ride**.
- 5 Press **▶** to start the activity timer.

Training for a Race Event

Your Edge bike computer can suggest daily workouts to help you train for a cycling event, if you have a VO2 max. estimate ([About VO2 Max. Estimates, page 14](#)) and ride with heart rate and power for one week.

- 1 On your phone or computer, go to your Garmin Connect calendar.
- 2 Select the day of the event, and add the race event.

You can search for an event in your area or create your own event.
- 3 Add details about the event, and add the course if it's available.
- 4 Sync your device with your Garmin Connect account.
- 5 On your device, scroll to the primary event glance to see a countdown to your primary race event.

Race Calendar and Primary Event

When you add a race event to your Garmin Connect calendar, you can view the event on your Edge bike computer by adding the primary event glance ([Customizing the Glances, page 59](#)). The event date must be in the next 365 days. The device displays a countdown to the event, event time and location, course details (if available), and weather information.

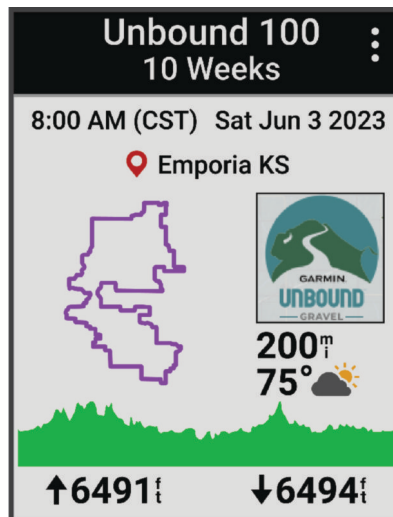

NOTE: Historical weather information for the location and date is available right away. Local forecast data appears approximately 14 days before the event.



From the primary event glance, swipe to view course information and weather details. Depending on the available course data for your event, you can view elevation data, the course map, course demands, and climb details.

Setting a Training Target

The training target feature works with the Virtual Partner® feature so you can train toward a set distance, distance and time, or distance and speed goal. During your training activity, the device gives you real-time feedback about how close you are to achieving your training target.

- 1 Select **Training > Set a Target**.
- 2 Select an option:
 - Select **Distance Only** to select a preset distance or enter a custom distance.
 - Select **Distance and Time** to select a distance and time target.
 - Select **Distance and Speed** to select a distance and speed target.

The training target screen appears, indicating your estimated finish time. The estimated finish time is based on your current performance and the time remaining.

- 3 Select ✓.
- 4 Press  to start the activity timer.
- 5 After you complete your activity, press , and select **Save**.

My Stats

The Edge 840 bike computer can track your personal statistics and calculate performance measurements. Performance measurements require a compatible heart rate monitor, power meter, or smart trainer.

Performance Measurements

These performance measurements are estimates that can help you track and understand your training activities and race performances. The measurements require a few activities using wrist-based heart rate or a compatible chest heart rate monitor. Cycling performance measurements require a heart rate monitor and a power meter.

These estimates are provided and supported by Firstbeat Analytics™. For more information, go to www.garmin.com/performance-data.

NOTE: The estimates may seem inaccurate at first. The device requires you to complete a few activities to learn about your performance.

Training status: Training status shows you how your training affects your fitness and performance. Your training status is based on changes to your training load and VO2 max. over an extended time period.

VO2 max.: VO2 max. is the maximum volume of oxygen (in milliliters) you can consume per minute per kilogram of body weight at your maximum performance. Your device displays heat and altitude corrected VO2 max. values when you are acclimating to high heat environments or high altitude.

Training load: Training load is the sum of your excess post-exercise oxygen consumption (EPOC) over the last 7 days. EPOC is an estimate of how much energy it takes for your body to recover after exercise.

Training load focus: Your device analyzes and distributes your training load into different categories based on the intensity and structure of each activity recorded. Training load focus includes the total load accumulated per category, and the focus of the training. Your device displays your load distribution over the last 4 weeks.

Recovery time: The recovery time displays how much time remains before you are fully recovered and ready for the next hard workout.

Functional threshold power (FTP): The device uses your user profile information from the initial setup to estimate your FTP. For a more accurate rating, you can conduct a guided test.

HRV stress test: The HRV (heart rate variability) stress test requires a Garmin chest heart rate monitor. The device records your heart rate variability while standing still for 3 minutes. It provides your overall stress level. The scale is 1 to 100, and a lower score indicates a lower stress level.

Performance condition: Your performance condition is a real-time assessment after 6 to 20 minutes of activity. It can be added as a data field so you can view your performance condition during the rest of your activity. It compares your real-time condition to your average fitness level.

Power curve: The power curve displays your sustained power output over time. You can view your power curve for the previous month, three months, or twelve months.

Training Status Levels

Training status shows you how your training affects your fitness level and performance. Your training status is based on changes to your VO2 max., acute load, and HRV status over an extended time period. You can use your training status to help plan future training and continue improving your fitness level.

No Status: The device needs you to record multiple activities over two weeks to determine your training status.

Detraining: You have a break in your training routine or you are training much less than usual for a week or more. Detraining means that you are unable to maintain your fitness level. You can try increasing your training load to see improvement.

Recovery: Your lighter training load is allowing your body to recover, which is essential during extended periods of hard training. You can return to a higher training load when you feel ready.

Maintaining: Your current training load is enough to maintain your fitness level. To see improvement, try adding more variety to your workouts or increasing your training volume.

Productive: Your current training load is moving your fitness level and performance in the right direction. You should plan recovery periods into your training to maintain your fitness level.

Peaking: You are in ideal race condition. Your recently reduced training load is allowing your body to recover and fully compensate for earlier training. You should plan ahead, since this peak state can only be maintained for a short time.

Overreaching: Your training load is very high and counterproductive. Your body needs a rest. You should give yourself time to recover by adding lighter training to your schedule.

Unproductive: Your training load is at a good level, but your fitness is decreasing. Try focusing on rest, nutrition, and stress management.

Strained: There is imbalance between your recovery and training load. It is a normal result after a hard training or major event. Your body may be struggling to recover, so you should pay attention to your overall health.

Tips for Getting Your Training Status

The training status feature depends on updated assessments of your fitness level, including at least one VO2 max. measurement per week. Your VO2 max. estimate is updated after both indoor and outdoor rides with power during which your heart rate reached at least 70% of your maximum heart rate for several minutes.

To get the most out of the training status feature, you can try these tips.

- At least one time per week, ride with a power meter, and reach a heart rate higher than 70% of your maximum heart rate for at least 10 minutes.
After using the device for one week, your training status should be available.
- Record all of your fitness activities on your primary training device, allowing your device to learn about your performance ([Syncing Activities and Performance Measurements, page 23](#)).

About VO2 Max. Estimates

VO2 max. is the maximum volume of oxygen (in milliliters) you can consume per minute per kilogram of body weight at your maximum performance. In simple terms, VO2 max. is an indication of athletic performance and should increase as your level of fitness improves. VO2 max. estimates are provided and supported by Firstbeat. You can use your Garmin device paired with a compatible heart rate monitor and power meter to display your cycling VO2 max. estimate.

Getting Your VO2 Max. Estimate

Before you can view your VO2 max. estimate, you must put on the heart rate monitor, install the power meter, and pair them with your device ([Pairing Your Wireless Sensors, page 45](#)). If your device was packaged with a heart rate monitor, the device and sensor are already paired. For the most accurate estimate, complete the user profile setup ([Setting Up Your User Profile, page 52](#)), and set your maximum heart rate ([Setting Your Heart Rate Zones, page 42](#)).

NOTE: The estimate may seem inaccurate at first. The device requires a few rides to learn about your cycling performance.

- 1 Ride at a steady, high intensity for at least 20 minutes.
- 2 After your ride, select **Save**.
- 3 Select **My Stats > Training Status**.
- 4 Swipe to view your VO2 max.

Your VO2 max. estimate appears as a number and position on the color gauge.

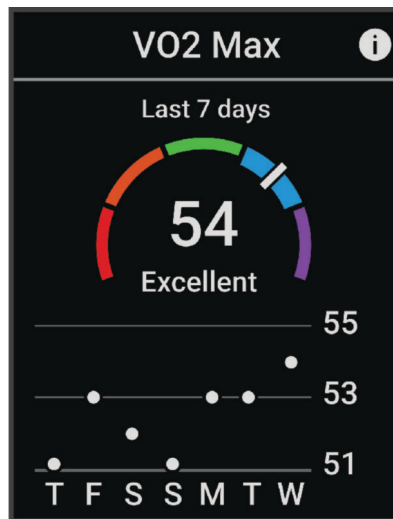

 Purple	Superior
 Blue	Excellent
 Green	Good
 Orange	Fair
 Red	Poor

VO2 max. data and analysis is provided with permission from The Cooper Institute®. For more information, see the appendix ([VO2 Max. Standard Ratings, page 83](#)), and go to www.CooperInstitute.org.

Tips for Cycling VO2 Max. Estimates

The success and accuracy of the VO2 max. calculation improves when your ride is a sustained and moderately hard effort, and where heart rate and power are not highly variable.

- Before your ride, check that your device, heart rate monitor, and power meter are functioning properly, paired, and have good battery life.
- During your 20 minute ride, maintain your heart rate at greater than 70% of your maximum heart rate.
- During your 20 minute ride, maintain a fairly constant power output.
- Avoid rolling terrain.
- Avoid riding in groups where there is a lot of drafting.

Heat and Altitude Performance Acclimation

Environmental factors such as high temperature and altitude impact your training and performance. For example, high altitude training can have a positive impact on your fitness, but you may notice a temporary VO2 max. decline while exposed to high altitudes. Your Edge 840 device provides acclimation notifications and corrections to your VO2 max. estimate and training status when the temperature is above 22°C (72°F) and when the altitude is above 800 m (2625 ft.).

NOTE: The heat acclimation feature is available only for GPS activities and requires weather data from your connected phone.

Acute Load

Acute load is a weighted sum of your excess post-exercise oxygen consumption (EPOC) for the last several days. The gauge indicates whether your current load is low, optimal, high, or very high. The optimal range is based on your individual fitness level and training history. The range adjusts as your training time and intensity increase or decrease.

Viewing Your Acute Load

Before you can view your acute load estimate, you must put on the heart rate monitor, install the power meter, and pair them with your device ([Pairing Your Wireless Sensors, page 45](#)).

If your device was packaged with a heart rate monitor, the device and sensor are already paired. For the most accurate estimate, complete the user profile setup ([Setting Up Your User Profile, page 52](#)), and set your maximum heart rate ([Setting Your Heart Rate Zones, page 42](#)).

NOTE: The estimate may seem inaccurate at first. The device requires a few rides to learn about your cycling performance.

- 1 Ride at least once during a seven day period.
- 2 Select  > **My Stats > Training Status.**
- 3 Swipe to view your acute load.

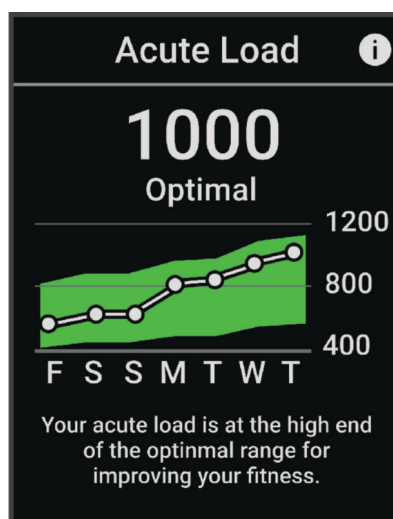

Training Load Focus

In order to maximize performance and fitness gains, training should be distributed across three categories: low aerobic, high aerobic, and anaerobic. Training load focus shows you how much of your training is currently in each category and provides training targets. Training load focus requires at least 7 days of training to determine if your training load is low, optimal, or high. After 4 weeks of training history, your training load estimate will have more detailed target information to help you balance your training activities.

Below targets: Your training load is lower than optimal in all intensity categories. Try increasing the duration or frequency of your workouts.

Low aerobic shortage: Try adding more low aerobic activities to provide recovery and balance for your higher intensity activities.

High aerobic shortage: Try adding more high aerobic activities to help improve your lactate threshold and VO2 max. over time.

Anaerobic shortage: Try adding a few more intense, anaerobic activities to improve your speed and anaerobic capacity over time.

Balanced: Your training load is balanced and provides all-around fitness benefits as you continue training.

Low aerobic focus: Your training load is mostly low aerobic activity. This provides a solid foundation and prepares you for adding more intense workouts.

High aerobic focus: Your training load is mostly high aerobic activity. These activities help to improve lactate threshold, VO2 max., and endurance.

Anaerobic focus: Your training load is mostly intense activity. This leads to rapid fitness gains, but should be balanced with low aerobic activities.

Above targets: Your training load is higher than optimal, and you should consider scaling back the duration and frequency of your workouts.

Viewing Cycling Ability

Before you can view your cycling ability, you must have a 7-day training history, VO2 max. data recorded in your user profile ([About VO2 Max. Estimates, page 14](#)), and power curve data from a paired power meter ([Viewing Your Power Curve, page 23](#)).

Cycling ability is a measurement of your performance across three categories: aerobic endurance, aerobic capacity, and anaerobic capacity. Cycling ability includes your current rider type, such as climber. Information you enter in your user profile, such as body weight, also helps determine your rider type ([Setting Up Your User Profile, page 52](#)).

1 From the home screen, swipe to view the cycling ability glance.

NOTE: You may need to add the glance to your home screen ([Viewing Glances, page 2](#)).

2 Select the cycling ability glance to view your current rider type.

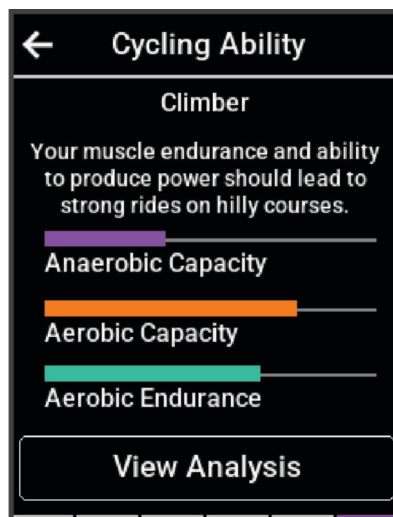

3 Select **View Analysis** to view a detailed analysis of your cycling ability.

About Training Effect

Training Effect measures the impact of an activity on your aerobic and anaerobic fitness. Training Effect accumulates during the activity. As the activity progresses, the Training Effect value increases. Training Effect is determined by your user profile information and training history, and heart rate, duration, and intensity of your activity. There are seven different Training Effect labels to describe the primary benefit of your activity. Each label is color coded and corresponds to your training load focus (*Training Load Focus*, page 17). Each feedback phrase, for example, "Highly Impacting VO2 Max." has a corresponding description in your Garmin Connect activity details.

Aerobic Training Effect uses your heart rate to measure how the accumulated intensity of an exercise affects your aerobic fitness and indicates if the workout had a maintaining or improving effect on your fitness level. Your excess post-exercise oxygen consumption (EPOC) accumulated during exercise is mapped to a range of values that account for your fitness level and training habits. Steady workouts at moderate effort or workouts involving longer intervals (>180 sec) have a positive impact on your aerobic metabolism and result in an improved aerobic Training Effect.

Anaerobic Training Effect uses heart rate and speed (or power) to determine how a workout affects your ability to perform at very high intensity. You receive a value based on the anaerobic contribution to EPOC and the type of activity. Repeated high-intensity intervals of 10 to 120 seconds have a highly beneficial impact on your anaerobic capability and result in an improved anaerobic Training Effect.

You can add Aerobic Training Effect and Anaerobic Training Effect as data fields to one of your training screens to monitor your numbers throughout the activity.

Training Effect	Aerobic Benefit	Anaerobic Benefit
From 0.0 to 0.9	No benefit.	No benefit.
From 1.0 to 1.9	Minor benefit.	Minor benefit.
From 2.0 to 2.9	Maintains your aerobic fitness.	Maintains your anaerobic fitness.
From 3.0 to 3.9	Impacts your aerobic fitness.	Impacts your anaerobic fitness.
From 4.0 to 4.9	Highly impacts your aerobic fitness.	Highly impacts your anaerobic fitness.
5.0	Overreaching and potentially harmful without enough recovery time.	Overreaching and potentially harmful without enough recovery time.

Training Effect technology is provided and supported by Firstbeat Analytics. For more information, go to www.firstbeat.com.

Recovery Time



You can use your Garmin device with wrist-based heart rate or a compatible chest heart rate monitor to display how much time remains before you are fully recovered and ready for the next hard workout.

NOTE: The recovery time recommendation uses your VO2 max. estimate and may seem inaccurate at first. The device requires you to complete a few activities to learn about your performance.

The recovery time appears immediately following an activity. The time counts down until it is optimal for you to attempt another hard workout. The device updates your recovery time throughout the day based on changes in sleep, stress, relaxation, and physical activity.

Viewing Your Recovery Time

Before you can use the recovery time feature, you must have a Garmin device with wrist-based heart rate or a compatible chest heart rate monitor paired with your device ([Pairing Your Wireless Sensors, page 45](#)). If your device was packaged with a heart rate monitor, the device and sensor are already paired. For the most accurate estimate, complete the user profile setup ([Setting Up Your User Profile, page 52](#)), and set your maximum heart rate ([Setting Your Heart Rate Zones, page 42](#)).

- 1 Select  > **My Stats** > **Recovery** >  > **Enable**.
- 2 Go for a ride.
- 3 After your ride, select **Save**.

The recovery time appears. The maximum time is 4 days, and the minimum time is 6 hours.

Getting Your Exercise Load Estimate

Before you can view your exercise load estimate, you must put on the heart rate monitor, install the power meter, and pair them with your device ([Pairing Your Wireless Sensors, page 45](#)).

If your device was packaged with a heart rate monitor, the device and sensor are already paired. For the most accurate estimate, complete the user profile setup ([Setting Up Your User Profile, page 52](#)), and set your maximum heart rate ([Setting Your Heart Rate Zones, page 42](#)).

NOTE: The estimate may seem inaccurate at first. The device requires a few rides to learn about your cycling performance.

- 1 Ride at least once during a seven day period.
- 2 Select  > **My Stats** > **Training Status**.
- 3 Swipe to view your exercise load.

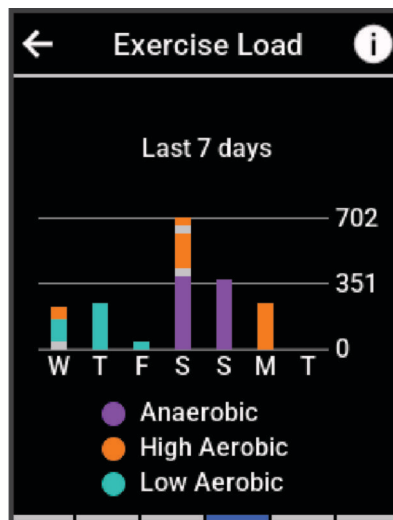

Getting Your FTP Estimate

The device uses your user profile information from the initial setup to estimate your functional threshold power (FTP). For a more accurate FTP value, you can conduct an FTP test using a paired power meter and heart rate monitor ([Conducting an FTP Test, page 20](#)).

Select  > **My Stats** > **Power** > **FTP**.

Your FTP estimate appears as a value measured in watts per kilogram, your power output in watts, and a position on the color gauge.

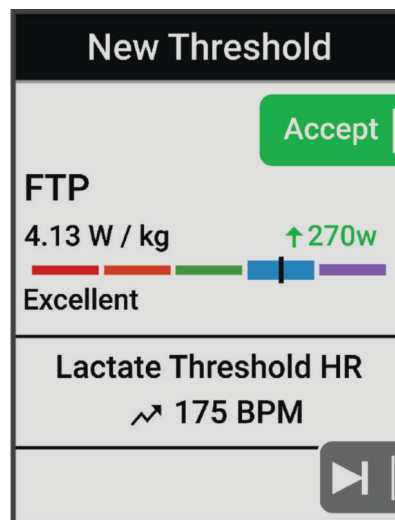

	Purple	Superior
	Blue	Excellent
	Green	Good
	Orange	Fair
	Red	Untrained

For more information, see the appendix ([FTP Ratings, page 83](#)).

Conducting an FTP Test

Before you can conduct a test to determine your functional threshold power (FTP), you must have a paired power meter and heart rate monitor ([Pairing Your Wireless Sensors, page 45](#)).

1 Select  > **My Stats** > **Power** > **FTP** >  > **FTP Test** > **Ride**.

2 Press  to start the activity timer.

After you begin your ride, the device displays each step of the test, the target, and current power data. A message appears when the test is complete.

3 Press  to stop the activity timer.



4 Select **Save**.

Your FTP appears as a value measured in watts per kilogram, your power output in watts, and a position on the color gauge.

Automatically Calculating FTP

Before the device can calculate your functional threshold power (FTP), you must have a paired power meter and heart rate monitor ([Pairing Your Wireless Sensors, page 45](#)).

NOTE: The estimate may seem inaccurate at first. The device requires a few rides to learn about your cycling performance.





- 1 Select  > **My Stats** > **Power** > **FTP** >  > **Auto Detect FTP**.
- 2 Ride at a steady, high intensity for at least 20 minutes outdoors.
- 3 After your ride, select **Save**.
- 4 Select  > **My Stats** > **Power** > **FTP**.

Your FTP appears as a value measured in watts per kilogram, your power output in watts, and a position on the color gauge.

Viewing Your Real-Time Stamina

Your device can provide real-time stamina estimates based on your heart rate data and VO2 max. estimate ([About VO2 Max. Estimates, page 14](#)). How hard you are working during an activity affects how quickly your stamina drains. Real-time stamina tracking works by combining your physiological metrics with your recent and long-term activity history, such as training duration, distance covered, and training load accumulation ([Performance Measurements, page 13](#)).

NOTE: For best results, record cycling activities with a power meter consistently for 2 to 3 weeks and with different intensity levels and duration.

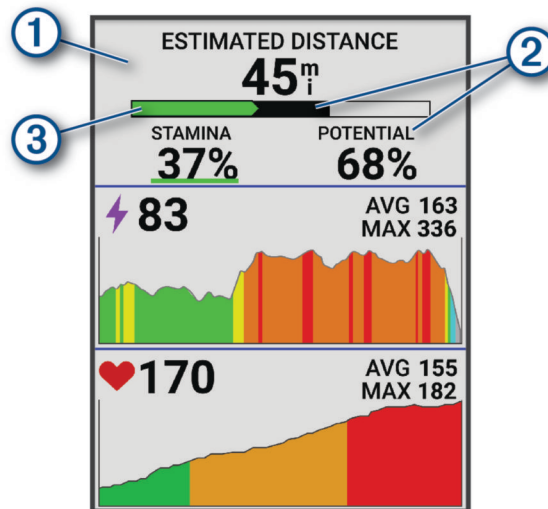

- 1 Select  > **Activity Profiles**.
- 2 Select a biking profile.
- 3 Select **Data Screens > Stamina**.
- 4 Select **Show Screen** to view the data screen during your ride.
- 5 Select **Show Current Effort**.
- 6 Select **Show Distance** or **Show Time** as the primary data field.
- 7 Select **Layout and Data Fields**.
- 8 Select  or  to change the layout.
- 9 Select .
- 10 Go for a ride ([Going for a Ride, page 3](#)).
- 11 Swipe left or right to view the data screen.



① Primary stamina data field. You can view the estimated time or distance remaining until you will reach exhaustion at your current effort level.

② Potential stamina estimate. Think of potential stamina as the total capacity of your fuel tank. It will decrease quickly if you are riding at a high effort level. Reducing your effort or resting results in a slower decline of your potential stamina.

Current stamina estimate. Your current stamina reflects how much you have left in the tank at your current level of effort. This estimate combines general fatigue with anaerobic cycling activities, such as sprints, climbs, and attacks.



- ③
-  Red: Stamina is depleting.
 -  Orange: Stamina is steady.
 -  Green: Stamina is recharging.

Viewing Your Stress Score

Before you can view your stress score, you must put on a chest heart rate monitor and pair it with your device ([Pairing Your Wireless Sensors, page 45](#)).

Stress score is the result of a three-minute test performed while standing still, where the Edge device analyzes heart rate variability to determine your overall stress. Training, sleep, nutrition, and general life stress all impact how an athlete performs. The stress score range is 1 to 100, where 1 is a very low stress state, and 100 is a very high stress state. Knowing your stress score can help you decide if your body is ready for a tough workout or yoga.



TIP: Garmin recommends that you measure your stress score at approximately the same time and under the same conditions every day.

- 1 Select  > **My Stats** > **Stress Score** > .
- 2 Stand still, and rest for 3 minutes.

Viewing Your Power Curve

Before you can view your power curve, you must pair your power meter with your device ([Pairing Your Wireless Sensors, page 45](#)).

The power curve displays your sustained power output over time. You can view your power curve for the previous month, three months, or twelve months.

- 1 Select  > **My Stats** > **Power**.
- 2 Swipe left to view your power curve.
- 3 Select  to select a time period.
- 4 Select a time period.

Syncing Activities and Performance Measurements

You can sync activities and performance measurements from other Garmin devices to your Edge 840 bike computer using your Garmin Connect account. This allows your device to more accurately reflect your training status and fitness. For example, you can record a run with a Forerunner® watch, and view your activity details and overall training load on your Edge 840 bike computer.

Sync your Edge 840 bike computer and other Garmin devices to your Garmin Connect account.

TIP: You can set a primary training device and primary wearable in the Garmin Connect app ([Unified Training Status, page 4](#)).

Recent activities and performance measurements from your other Garmin devices appear on your Edge 840 bike computer.

Turning Off Performance Notifications



Performance notifications are turned on by default. Some performance notifications are alerts that appear upon completion of your activity. Some performance notifications appear during an activity or when you achieve a new performance measurement, such as a new VO2 max. estimate.

- 1 Select  > **My Stats** > **Performance Notifications**.
- 2 Select an option.

Pausing Your Training Status

If you are injured or sick, you can pause your training status. You can continue to record fitness activities, but your training status, training load focus, recovery feedback, and workout recommendations are temporarily disabled.

Select an option:



- From your Edge bike computer, select  > **My Stats** > **Training Status** >  > **Pause Training Status**.
- From your Garmin Connect settings, select **Performance Stats** > **Training Status** >  > **Pause Training Status**.

TIP: You should sync your device with your Garmin Connect account.

Resuming Your Paused Training Status

You can resume your training status when you are ready to start training again. For best results, you need at least two VO2 max. measurements each week ([About VO2 Max. Estimates, page 14](#)).

Select an option:

- From your Edge bike computer, select  > **My Stats** > **Training Status** >  > **Resume Training Status**.
- From your Garmin Connect settings, select **Performance Stats** > **Training Status** >  > **Resume Training Status**.

TIP: You should sync your device with your Garmin Connect account.

Viewing Your Fitness Age

Before the device can calculate an accurate fitness age, you must complete the user profile setup in the Garmin Connect app.

Your fitness age gives you an idea of how your fitness compares with a person of the same sex. Your device uses information, such as your age, body mass index (BMI), resting heart rate data, and vigorous activity history to provide a fitness age. If you have a Garmin Index™ scale, your device uses the body fat percentage metric instead of BMI to determine your fitness age. Exercise and lifestyle changes can impact your fitness age.

Select  > **My Stats** > **Fitness Age**.

Viewing Intensity Minutes

Before the device can calculate your intensity minutes, you must pair your device and go for a ride with a compatible heart rate monitor ([Pairing Your Wireless Sensors, page 45](#)).

To improve your health, organizations such as the World Health Organization recommend at least 150 minutes per week of moderate intensity activity or 75 minutes per week of vigorous intensity activity. The Edge device, when paired with a heart rate monitor, tracks your time spent participating in moderate to vigorous activities, your weekly intensity minutes goal, and progress toward your goal.

Select  > **My Stats** > **Intensity Minutes**.

Personal Records



When you complete a ride, the device displays any new personal records you achieved during that ride. Personal records include your fastest time over a standard distance, longest ride, and most ascent gained during a ride. When paired with a compatible power meter, the device displays the maximum power reading recorded during a 20-minute period.

Viewing Your Personal Records

Select  > **My Stats** > **Personal Records**.



Reverting a Personal Record

You can set each personal record back to the one previously recorded.

- 1 Select  > **My Stats** > **Personal Records**.
- 2 Select a record to revert.
- 3 Select **Previous Record** > .

NOTE: This does not delete any saved activities.

Deleting a Personal Record

- 1 Select  > **My Stats** > **Personal Records**.
- 2 Select a personal record.
- 3 Select  > .

Training Zones

- Heart rate zones ([Setting Your Heart Rate Zones, page 42](#))
- Power zones ([Setting Your Power Zones, page 45](#))

Navigation

Navigation features and settings also apply to navigating courses ([Courses, page 27](#)) and segments ([Segments, page 8](#)).

- Locations and finding places ([Locations, page 25](#))
- Planning a course ([Courses, page 27](#))
- Route settings ([Route Settings, page 33](#))
- Map settings ([Map Settings, page 32](#))

Locations

You can record and store locations in the device.



Marking Your Location

Before you can mark a location, you must locate satellites.

If you want to remember landmarks or return to a certain spot, you can mark a location.



- 1 Go for a ride.
- 2 Select **Navigation** >  > **Mark Location** > .

Saving Locations from the Map

- 1 Select **Navigation** > **Browse Map**.
- 2 Browse the map for the location.
- 3 Select the location.
Location information appears at the top of the map.
- 4 Select the location information.
- 5 Select  > **Save Location** > .

Navigating to a Location

TIP: You can use the Location Search glance to perform a quick search from the home screen. If necessary, you can add the glance to the glance loop (*Customizing the Glances, page 59*).

- 1 Select **Navigation**.
- 2 Select an option:
 - Select **Browse Map** to navigate to a location on the map.
 - Select **Courses** to navigate using a saved course (*Courses, page 27*).
 - Select **MTB Trail Navigation** to navigate to a mountain bike trail network.
 - Select **Search** to navigate to a point of interest, city, address, intersection, or known coordinates.
TIP: You can select  to enter specific search information.
 - Select **Saved Locations** to navigate to a saved location.
 - Select **Recent Finds** to navigate to one of the last 50 locations you have found.
 - Select  > **Searching near:** to narrow your search area.
- 3 Select a location.
- 4 Select **Ride**.
- 5 Follow the on-screen instructions to your destination.

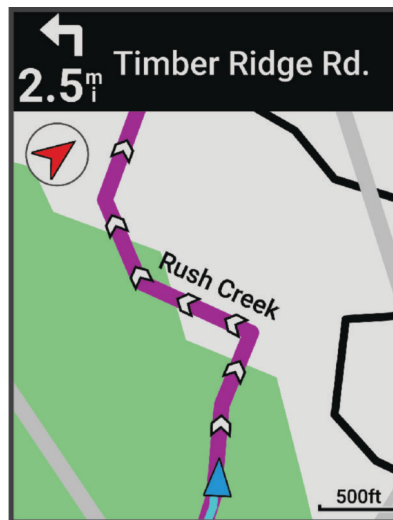

Navigating Back to Start

At any point during your ride, you can return to the starting point.

- 1 Go for a ride.
- 2 At any time, swipe down from the top of the screen, and on the controls widget, select **Back to Start**.
- 3 Select **Along Same Route** or **Most Direct Route**.
- 4 Select **Ride**.
The device navigates you back to the starting point of your ride.

Stopping Navigation

- 1 Tap the screen.
- 2 Select **Stop Navigation** > .

Editing Locations

- 1 Select **Navigation > Saved Locations**.
- 2 Select a location.
- 3 Select the information bar at the top of the screen.
- 4 Select **Edit**.
- 5 Select an option.
For example, select Change Elevation to enter a known altitude for the location.
- 6 Enter the new information, and select .

Deleting a Location

- 1 Select **Navigation > Saved Locations**.
- 2 Select a location.
- 3 Select the location information at the top of the screen.
- 4 Select **Edit > Delete Location > **.

Courses





You can send a course from your Garmin Connect account to your device. After it is saved to your device, you can navigate the course on your device.

You can follow a saved course simply because it is a good route. For example, you can save and follow a bike friendly commute to work. You can also follow a saved course, trying to match or exceed previously set performance goals.

Planning and Riding a Course

You can create and ride a custom course. A course is a sequence of waypoints or locations that leads you to your final destination.

TIP: You can also create a custom course in the Garmin Connect app and send it to your device ([Following a Course From Garmin Connect, page 29](#)).

- 1 Select **Navigation > Courses >  > Course Creator**.
- 2 Select  to add a location.
- 3 Select an option:
 - To select your current location on the map, select **Current Location**.
 - To select a location on the map, select **Use Map**, and select a location.
 - To select a saved location, select **Saved & Recent > Saved Locations**, and select a location.
 - To select a saved segment, select **Saved & Recent > Segments**, and select a segment.
 - To select a location for which you recently searched, select **Saved & Recent > Recent Finds**, and select a location.
 - To browse for and select a point of interest, select **Points of Interest**, and select a nearby point of interest.
 - To select a city, select **Cities**, and select a nearby city.
 - To select an address, select **Search Tools > Addresses**, and enter the address.
 - To select an intersection, select **Search Tools > Intersections**, and enter the street names.
 - To use coordinates, select **Search Tools > Coordinates**, and enter the coordinates.
- 4 Select **Add to Course**.
TIP: From the map, you can select another location, and select Add to Course to continue adding locations.
- 5 Repeat steps 2 through 4 until you have selected all locations for the route.
- 6 If necessary, select an option:
 - Hold  on a location and drag it to reorder the list.
 - Swipe left and select  to remove a location.



- 7 Select an option:
 - To calculate the route, select **View Map**.
 - To calculate the route with the same route back to the start location, select **+** > **Out and Back**.
 - To calculate the route with a different route back to the start location, select **+** > **Loop to Start**.A map of the course appears.
- 8 Select **Save**.
- 9 Enter a name for the course.
- 10 Select **✓** > **Ride**.

Creating and Riding a Round-Trip Course

The device can create a round-trip course based on a specified distance, starting location, and direction of navigation.

- 1 Select **Navigation** > **Courses** > **+** > **Round-Trip Course**.
- 2 Select **Distance**, and enter the total distance for the course.
- 3 Select **Start Location**.
- 4 Select an option:
 - To select your current location, select **Current Location**.
 - To select a location on the map, select **Use Map**, and select a location.
 - To select a saved location, select **Saved Locations**, and select a location.
 - To select a location for which you recently searched, select **Recent Finds**, and select a location.
 - To browse for and select a point of interest, select **Points of Interest**, and select a nearby point of interest.
 - To select an address, select **Search Tools** > **Addresses**, and enter the address.
 - To select an intersection, select **Search Tools** > **Intersections**, and enter the street names.
 - To use coordinates, select **Search Tools** > **Coordinates**, and enter the coordinates.
- 5 Select **Start Direction**, and select a direction heading.
- 6 Select **Search**.

TIP: You can select  to search again.
- 7 Select a course to view it on the map.

TIP: You can select  and  to view the other courses.
- 8 Select **Save** > **Ride**.

Creating a Course from a Recent Ride

You can create a new course from a ride you saved on this Edge device.

- 1 Select **History** > **Rides**.
- 2 Select a ride.
- 3 Select **⋮** > **Save Ride as Course**.
- 4 Enter a name for the course, and select **✓**.

Following a Course From Garmin Connect

Before you can download a course from Garmin Connect, you must have a Garmin Connect account ([Garmin Connect, page 50](#)).

- 1 Select an option:
 - Open the Garmin Connect app.
 - Go to connect.garmin.com.
- 2 Create a new course, or select an existing course.
- 3 Select an option:
 - On the Garmin Connect app, select  > **Send to Device**.
 - On the Garmin Connect website, select **Send to Device**.
- 4 Select your Edge device.
- 5 Select an option:
 - Sync your device with the Garmin Connect app.
 - Sync your device using the Garmin Express™ application.

On the Edge device, the course appears on the home screen.
- 6 Select the course.
NOTE: If necessary, you can select **Navigation > Courses** to select a different course.
- 7 Select **Ride**.

Tips for Riding a Course

- Use turn guidance ([Course Options, page 30](#)).
- If you include a warmup, press  to begin the course, and warm up as normal.
- Stay away from your course path as you warm up.
When you are ready to begin, head toward your course. When you are on any part of the course path, a message appears.
- Scroll to the map to view the course map.
If you stray from the course, a message appears.

Viewing Course Details

- 1 Select **Navigation > Courses**.
- 2 Select a course.
- 3 Select an option:
 - Select the course to view the course on the map.
 - Select the climbs graph to view details and elevation plots for each climb.
 - Select **Summary** to view details about the course.
 - Select **Course Demands** to view an analysis of your cycling ability for the course.
 - Select **Power Guide** to view an analysis of your effort for the course.

Displaying a Course on the Map

For each course saved to your device, you can customize how it appears on the map. For example, you can set your commute course to always display on the map in yellow. You can have an alternate course display in green. This allows you to see the courses while you are riding, but not follow or navigate a particular course.

- 1 Select **Navigation > Courses**.
- 2 Select the course.
- 3 Select .
- 4 Select **Always Display** to make the course appear on the map.
- 5 Select **Color**, and select a color.
- 6 Select **Course Points** to include course points on the map.

The next time you ride near the course, it appears on the map.

Course Options

Select **Navigation > Courses > **.

Turn Guidance: Enables or disables turn prompts.

Off Course Warnings: Alerts you if you stray from the course.

Search: Allows you to search for saved courses by name.

Sort: Allows you to sort saved courses by name, distance, or date.

Delete: Allows you to delete all or multiple saved courses from the device.

Rerouting a Course

You can choose how the device recalculates the route when you go off course.

When you go off course, select an option:

- To pause navigation until you get back on course, select **Pause Navigation**.
- To choose from rerouting suggestions, select **Re-route**.

NOTE: The first rerouting option is the shortest route back to the course and starts automatically after 10 seconds.

Stopping a Course

- 1 Scroll to the map.
- 2 Swipe down from the top of the screen, and scroll to the controls widget.
- 3 Select **Stop Course > **.

Deleting a Course

- 1 Select **Navigation > Courses**.
- 2 Swipe left on a course.
- 3 Select .

Trailforks Routes

With the Trailforks app, you can save your favorite trail routes or browse for routes nearby. You can download Trailforks mountain bike trail routes to your Edge bike computer. Downloaded routes appear in the saved courses list.

To sign up for a Trailforks membership, go to www.trailforks.com.

Using ClimbPro

The ClimbPro feature helps you manage your effort for upcoming climbs. You can view details about the climbs, including when they occur, average gradient, and total ascent. The climb scores, based on length and gradient, are indicated by color ([Climb Categories](#), page 32).

- 1 Enable the ClimbPro feature for the activity profile ([Training Settings](#), page 53).
- 2 Select **Climb Detection**.
- 3 Select an option:
 - Select **All Climbs** to show climbs with a climb score of 1,500 or greater.
 - Select **Medium to Large Climbs** to show climbs with a climb score of 3,500 or greater.
 - Select **Only Large Climbs** to show climbs with a climb score of 8,000 or greater.
- 4 Select **Mode**.
- 5 Select an option:
 - Select **When Navigating** to use ClimbPro only when you are following a course ([Courses](#), page 27) or navigating to a destination ([Navigating to a Location](#), page 26).
 - Select **Always** to use ClimbPro with all rides.
- 6 Review the climbs in the climb explore widget.
TIP: Climbs also appear in the course details ([Viewing Course Details](#), page 29).
- 7 Go for a ride.

At the start of a climb, the ClimbPro screen appears automatically.

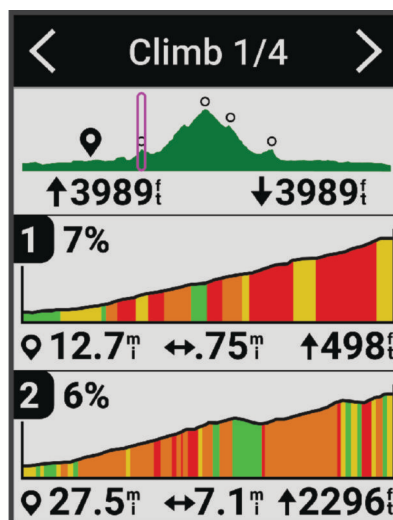







After you save the ride, you can view the climb splits in your ride history.

Using the Climb Explore Widget

- 1 Scroll to the climb explore widget.
TIP: You can add the climb explore widget to the widget loop ([Customizing the Widget Loop](#), page 59).
- 2 Select **⋮**.
- 3 Select an option:
 - Select **Search Radius** to enter the distance to search for climbs.
 - Select **Min Difficulty** to set the minimum climb category ([Climb Categories](#), page 32).
 - Select **Max Difficulty** to set the maximum climb category ([Climb Categories](#), page 32).
 - Select **Terrain Type** to indicate what type of terrain you will be riding on.
 - Select **Sort by** to sort the climbs by distance, ascent, length, or grade.
 - Select **Sort Order** to sort the climbs in ascending or descending order.

Climb Categories

Climb categories are determined by climb score, which is calculated using the grade multiplied by the length of the climb. A climb must have a length of at least 500 meters and an average grade of at least 3 percent, or a climb score of 1,500, to be considered a climb.

Category	Climb Score	Color
Hors Category (HC)	Greater than 80,000	
Category 1	Greater than 64,000	
Category 2	Greater than 32,000	
Category 3	Greater than 16,000	
Category 4	Greater than 8,000	
Uncategorized	Greater than 1,500	

Map Settings

Select  > **Activity Profiles**, select a profile, and select **Navigation** > **Map**.

Orientation: Sets how the map is shown on the page.

Auto Zoom: Automatically selects a zoom level for the map. When Off is selected, you must zoom in or out manually.

Guide Text: Sets when the turn-by-turn navigation prompts are shown (requires routable maps).

Appearance: Customizes the appearance settings on the map ([Map Appearance Settings, page 32](#)).

Map Information: Enables or disables the maps currently loaded on the device.

Map Appearance Settings

Select  > **Activity Profiles**, select a profile, and select **Navigation** > **Map** > **Appearance**.

Map Theme: Adjusts the appearance of the map for your ride type. ([Map Themes, page 33](#))

Popularity Map: Highlights popular roads or trails for your ride type. The darker the road or trail, the more popular.

Map Detail: Sets the level of detail shown on the map.

History Line Color: Allows you to change the line color of the path you have traveled.

Advanced: Allows you to set zoom levels and text size, and enable shaded relief and contours.

Reset Map Default: Resets the map appearance to the default settings.

Changing the Map Orientation

1 Select  > **Activity Profiles**.

2 Select a profile.

3 Select **Navigation** > **Map** > **Orientation**.

4 Select an option:

- Select **North Up** to show north at the top of the page.
- Select **Track Up** to show your current direction of travel at the top of the page.

Map Themes

You can change the map theme to adjust the appearance of the map for your ride type.

Select  > **Activity Profiles**, select a profile, and select **Navigation > Map > Appearance > Map Theme**.

Classic: Uses the classic Edge map color scheme, with no additional theme applied.

High Contrast: Sets the map to display data with higher contrast, for better visibility in challenging environments.

Mountain Biking: Sets the map to optimize trail data in mountain biking mode.

Route Settings

Select  > **Activity Profiles**, select a profile, and select **Navigation > Routing**.

Popularity Routing: Calculates routes based on the most popular rides from Garmin Connect.

Routing Mode: Sets the transportation method to optimize your route.

Calculation Method: Sets the method used to calculate your route.

Lock on Road: Locks the position icon, which represents your position on the map, onto the nearest road.

Avoidance Setup: Sets the road types to avoid while navigating.

Course Recalculation: Automatically recalculates the route when you deviate from the course.

Route Recalculation: Automatically recalculates the route when you deviate from the route.

Selecting an Activity for Route Calculation

You can set the device to calculate the route based on activity type.

- 1 Select  > **Activity Profiles**.
- 2 Select a profile.
- 3 Select **Navigation > Routing > Routing Mode**.
- 4 Select an option to calculate your route.

For example, you can select Road Cycling for on-road navigation or Mountain Biking for off-road navigation.

Connected Features

WARNING

While cycling, do not interact with the display to enter information or to read or reply to messages, because doing so can cause a distraction that could lead to an accident causing serious personal injury or death.

Connected features are available for your Edge bike computer when you connect the bike computer to a Wi-Fi® network or to a compatible phone using Bluetooth® technology.

Pairing Your Phone

To use the connected features of the Edge device, it must be paired directly through the Garmin Connect app, instead of from the Bluetooth settings on your phone.

- 1 Hold  to turn on the device.

The first time you turn on the device, you will select the device language. The next screen prompts you to pair with your phone.

TIP: You can swipe down on the home screen to view the settings widget, and select **Phone > Pair Smartphone** to manually enter pairing mode.

- 2 Scan the QR code with your phone, and follow the on-screen instructions to complete the pairing and setup process.

NOTE: Based on your Garmin Connect account and accessories, your device suggests activity profiles and data fields during setup. If you have sensors paired with your previous device, you can transfer them during setup.

NOTE: Setting up Wi-Fi and sleep mode usage on your device enables the device to sync with all your data such as training stats, course downloads, and software updates.

After you pair successfully, a message appears, and your device syncs automatically with your phone.

Bluetooth Connected Features

The Edge device has several Bluetooth connected features for your compatible phone using the Garmin Connect and Connect IQ™ apps. Go to www.garmin.com/intosports/apps for more information.

Activity uploads to Garmin Connect: Automatically sends your activity to Garmin Connect as soon as you finish recording the activity.

Audio prompts: Allows the Garmin Connect app to play status announcements on your phone during a ride.

Bike alarm: Allows you to enable an alarm that sounds on the device and sends an alert to your phone when the device detects motion.

Connect IQ downloadable features: Allows you to download Connect IQ features from the Connect IQ app.

Course, segment, and workout downloads from Garmin Connect: Allows you to search for activities on Garmin Connect using your phone and send them to your device.

Device to device transfers: Allows you to wirelessly transfer files to another compatible Edge device.

Find my Edge: Locates your lost Edge device that is paired with your phone and currently within range.

Messages: Allows you to reply to an incoming call or text message with a preset text message. This feature is available with compatible Android™ phones.

Notifications: Displays phone notifications and messages on your device.

Safety and tracking features: (*Safety and Tracking Features, page 35*)

Social media interactions: Allows you to post an update to your favorite social media website when you upload an activity to Garmin Connect.

Weather updates: Sends real-time weather conditions and alerts to your device.

Safety and Tracking Features

⚠ CAUTION

The safety and tracking features are supplemental features and should not be relied on as a primary method to obtain emergency assistance. The Garmin Connect app does not contact emergency services on your behalf.

NOTICE

To use these features, the Edge 840 device must have GPS enabled and be connected to the Garmin Connect app using Bluetooth technology. You can enter emergency contacts in your Garmin Connect account.

The Edge 840 device has safety and tracking features that must be set up with the Garmin Connect app.

For more information about safety and tracking features, go to www.garmin.com/safety.

Assistance: Allows you to send a message with your name, LiveTrack link, and GPS location (if available) to your emergency contacts.

Incident detection: When the Edge 840 device detects an incident during certain outdoor activities, the device sends an automated message, LiveTrack link, and GPS location (if available) to your emergency contacts.

LiveTrack: Allows friends and family to follow your races and training activities in real time. You can invite followers using email or social media, allowing them to view your live data on a web page.

GroupTrack: Allows you to keep track of your connections using LiveTrack directly on screen and in real time.

Incident Detection

⚠ CAUTION

Incident detection is a supplemental feature available only for certain outdoor activities. Incident detection should not be relied on as a primary method to obtain emergency assistance. The Garmin Connect app does not contact emergency services on your behalf.

NOTICE

Before you can enable incident detection on your device, you must set up emergency contact information in the Garmin Connect app. Your paired phone must be equipped with a data plan and be in an area of network coverage where data is available. Your emergency contacts must be able to receive text messages (standard text messaging rates may apply).

When an incident is detected by your Edge device with GPS enabled, the Garmin Connect app can send an automated text message and email with your name and GPS location, if available, to your emergency contacts. A message appears on your device and paired phone indicating your contacts will be informed after 30 seconds have elapsed. If assistance is not needed, you can cancel the automated emergency message.

Assistance

⚠ CAUTION

Assistance is a supplemental feature and should not be relied on as a primary method to obtain emergency assistance. The Garmin Connect app does not contact emergency services on your behalf.

NOTICE



Before you can enable the assistance feature on your device, you must set up emergency contact information in the Garmin Connect app. Your paired phone must be equipped with a data plan and be in an area of network coverage where data is available. Your emergency contacts must be able to receive text messages (standard text messaging rates may apply).

When your Edge device with GPS enabled is connected to the Garmin Connect app, you can send an automated text message with your name and GPS location, if available, to your emergency contacts.

A message appears on your device indicating your contacts will be informed after a countdown has elapsed. If assistance is not needed, you can cancel the message.

Adding Emergency Contacts

Emergency contact phone numbers are used for the safety and tracking features.

- 1 From the Garmin Connect app, select  or .
- 2 Select **Safety & Tracking > Safety Features > Emergency Contacts > Add Emergency Contacts**.
- 3 Follow the on-screen instructions.

Your emergency contacts receive a notification when you add them as an emergency contact, and can accept or decline your request. If a contact declines, you must choose another emergency contact.

Viewing Your Emergency Contacts

Before you can view your emergency contacts on your device, you must set up your rider information and emergency contacts in the Garmin Connect app.



Select  > **Safety & Tracking > Emergency Contacts**.

Your emergency contacts' names and phone numbers appear.

Requesting Assistance

NOTICE

Before you can request assistance, you must enable GPS on your Edge device and set up emergency contact information in the Garmin Connect app. Your paired phone must be equipped with a data plan and be in an area of network coverage where data is available. Your emergency contacts must be able to receive emails or text messages (standard text messaging rates may apply).

- 1 Hold  for five seconds to activate the assistance feature.
The device beeps and sends the message after the five-second countdown is complete.
TIP: You can select  before the countdown is complete to cancel the message.
- 2 If necessary, select **Send** to send the message immediately.

Turning Incident Detection On and Off

NOTE: Your paired phone must be equipped with a data plan and be in an area of network coverage where data is available.

- 1 Select  > **Safety & Tracking > Incident Detection**.
- 2 Select the activity profile to enable incident detection.

NOTE: Incident detection is enabled by default for certain outdoor activities. Depending on the terrain and your riding style, false positives can occur.

Cancelling an Automated Message

When an incident is detected by your device, you can cancel the automated emergency message on your device or your paired phone before it is sent to your emergency contacts.

Before the end of the 30-second countdown, hold **Hold to Cancel**.

Sending a Status Update After an Incident

Before you can send a status update to your emergency contacts, your device must detect an incident and send an automated emergency message to your emergency contacts.

You can send a status update to your emergency contacts informing them you are not in need of assistance.

- 1 Swipe down from the top of the screen, and swipe left or right to view the controls widget.
- 2 Select **Incident Detected > I'm Okay**.
A message is sent to all emergency contacts.

Turning On LiveTrack

Before you can start your first LiveTrack session, you must set up contacts in the Garmin Connect app.





- 1 Select  > **Safety & Tracking** > **LiveTrack**.
- 2 Select an option:
 - Select **Auto Start** to start a LiveTrack session each time you start this type of activity.
 - Select **LiveTrack Name** to update the name of your LiveTrack session. The current date is the default name.
 - Select **Recipients** to view recipients.
 - Select **Course Sharing** if you want your recipients to see your course.
 - Select **Spectator Messaging** if you want to allow your recipients to send you text messages during your cycling activity ([Spectator Messaging, page 38](#)).
 - Select **Extend LiveTrack** to extend viewing of the LiveTrack session for 24 hours.
- 3 Select **Start LiveTrack**.

Recipients can view your live data on a Garmin Connect tracking page.

Starting a GroupTrack Session

Before you can start a GroupTrack session, you must have a phone with the Garmin Connect app paired to your device ([Pairing Your Phone, page 34](#)).

During a ride, you can see the riders in your GroupTrack session on the map.

- 1 On the Edge bike computer, select  > **Safety & Tracking** > **GroupTrack** to enable viewing connections on the map screen.
- 2 From the Garmin Connect app, select  or .
- 3 Select **Safety & Tracking** > **LiveTrack** >  > **Settings** > **GroupTrack** > **All Connections**.
- 4 Select **Start LiveTrack**.
- 5 On the Edge bike computer, press , and go for a ride.
- 6 Scroll to the map to view your connections.





You can tap an icon on the map to view location and heading information for other riders in the GroupTrack session.

- 7 Scroll to the GroupTrack list.
You can select a rider from the list, and that rider appears centered on the map.

Tips for GroupTrack Sessions

The GroupTrack feature allows you to keep track of other riders in your group using LiveTrack directly on the screen. All riders in the group must be your connections in your Garmin Connect account.

- Ride outside using GPS.
- Pair your Edge 840 device with your phone using Bluetooth technology.
- In the Garmin Connect app, select  or , and select **Connections** to update the list of riders for your GroupTrack session.
- Make sure all of your connections pair to their phones and start a LiveTrack session in the Garmin Connect app.
- Make sure all your connections are in range (40 km or 25 mi.).
- During a GroupTrack session, scroll to the map to view your connections.
- Stop riding before you attempt to view location and heading information for other riders in the GroupTrack session.

Live Event Sharing

Live event sharing allows you to send messages to friends and family during an event, providing real-time updates including cumulative time and last lap time. Before the event, you can customize the list of recipients and the message content in the Garmin Connect app.

Turning On Live Event Sharing

Before you can use live event sharing, you must set up the LiveTrack feature in the Garmin Connect app.

NOTE: LiveTrack features are available when your device is connected to the Garmin Connect app using Bluetooth technology, with a compatible Android phone.

- 1 Turn on your Edge bike computer.
- 2 In the Garmin Connect app, from the settings menu, select **Safety & Tracking > Live Event Sharing**.
- 3 Select **Devices**, and select your Edge bike computer.
- 4 Select the toggle switch to enable **Live Event Sharing**.
- 5 Select **Done**.
- 6 Select **Recipients** to add people from your contacts.
- 7 Select **Message Options** to customize the message triggers and options.
- 8 Go outside, and select a GPS biking profile on your Edge 840 bike computer.

Live event sharing is enabled for 24 hours.

Spectator Messaging

NOTE: Your paired phone must be equipped with a data plan and be in an area of network coverage where data is available.

Spectator messaging is a feature that allows your LiveTrack followers to send you text messages during your cycling activity. You can set up this feature in the LiveTrack settings of the Garmin Connect app.

Blocking Spectator Messages

If you want to block spectator messages, Garmin recommends turning them off before you start the activity.

Select  > **Safety & Tracking > LiveTrack > Spectator Messaging**.

Setting the Bike Alarm

You can turn on the bike alarm when you are away from your bike, such as on a stop during a long ride. You can control the bike alarm from your device or the device settings in the Garmin Connect app.



- 1 Select  > **Safety & Tracking > Bike Alarm**.
- 2 Create or update your passcode.
When you disable the bike alarm from your Edge device, you are prompted to enter the passcode.
- 3 Swipe down from the top of the screen, and on the controls widget, select **Set Bike Alarm**.

If the device detects motion, it sounds an alarm and sends an alert to your connected phone.

Playing Audio Prompts on Your Phone

Before you can set up audio prompts, you must have a phone with the Garmin Connect app paired to your Edge device.

You can set the Garmin Connect app to play motivational status announcements on your phone during a ride or other activity. Audio prompts include the lap number and lap time, navigation, power, pace or speed, and heart rate data. During an audio prompt, the Garmin Connect app mutes the primary audio of the phone to play the announcement. You can customize the volume levels on the Garmin Connect app.

- 1 From the Garmin Connect app, select  or .
- 2 Select **Garmin Devices**.
- 3 Select your device.
- 4 Select **Audio Prompts**.

Listening to Music

WARNING

Do not listen to music while cycling on public roadways, as this can cause distraction leading to an accident resulting in personal injury or death. It is the user's responsibility to know and understand local laws and regulations relating to headphone usage while cycling.

- 1 Go for a ride.
- 2 While stopped, swipe down from the top of the screen to view the widgets.
- 3 Swipe left or right to view the music controls widget.
NOTE: You can add options to the widget loop (*Customizing the Widget Loop, page 59*).
- 4 Start listening to music from your paired phone.

You can control music playback on your phone from your Edge bike computer.

Wi-Fi Connectivity Features

Activity uploads to your Garmin Connect account: Automatically sends your activity to your Garmin Connect account as soon as you finish recording the activity.

Software updates: You can download and install the latest software.

Workouts and training plans: You can browse for and select workouts and training plans on the Garmin Connect website. The next time your device has a Wi-Fi connection, the files are sent to your device.

Setting Up Wi-Fi Connectivity

You must connect your device to the Garmin Connect app on your phone or to the Garmin Express application on your computer before you can connect to a Wi-Fi network.

- 1 Select an option:
 - Download the Garmin Connect app, and pair your phone (*Pairing Your Phone, page 34*).
 - Go to www.garmin.com/express, and download the Garmin Express application.
- 2 Follow the on-screen instructions to set up Wi-Fi connectivity.

Wi-Fi Settings

Select  > **Connected Features** > **Wi-Fi**.

Wi-Fi: Enables Wi-Fi wireless technology.

NOTE: Other Wi-Fi settings appear only when Wi-Fi is enabled.

Auto Upload: Allows you to upload activities automatically over a known wireless network.

Add Network: Connects your device to a wireless network.

Wireless Sensors

Your Edge bike computer can be paired and used with wireless sensors using ANT+ or Bluetooth technology ([Pairing Your Wireless Sensors, page 45](#)). After the devices are paired, you can customize the optional data fields ([Adding a Data Screen, page 54](#)). If your device was packaged with a sensor, they are already paired.

For information about specific Garmin sensor compatibility, purchasing, or to view the owner's manual, go to buy.garmin.com for that sensor.

Sensor Type	Description
eBike	You can use your device with your eBike and view bike data, such as battery and shifting information, during your rides (Viewing eBike Sensor Details, page 48).
Edge Remote	You can control your Edge bike computer with the Edge remote, including starting the activity timer, marking laps, and scrolling through data screens.
Extended Display	You can use the Extended Display mode to display data screens from your compatible Garmin watch on a compatible Edge bike computer during a ride or triathlon.
Heart Rate	You can use an external sensor, such as the HRM-Pro™ or HRM-Dual™ heart rate monitor, to view heart rate data during your activities.
inReach Remote	The inReach® remote function allows you to control your inReach satellite communicator using your Edge bike computer (Using the inReach Remote, page 49).
Lights	You can use Varia™ smart bike lights to improve situational awareness.
Power	You can use the Rally™ or Vector™ power meter bike pedals to view power data on your device. You can adjust the power zones to match your goals and abilities (Setting Your Power Zones, page 45), or use range alerts to be notified when you reach a specified power zone (Setting Range Alerts, page 55).
Radar	You can use a Varia rearview bike radar to improve situational awareness and send alerts about approaching vehicles. With a Varia radar camera tail light, you can also take photos and record video during a ride (Using the Varia Camera Controls, page 48).
Shifting	You can use electronic shifters to display shifting information during a ride. The Edge 840 device displays current adjustment values when the sensor is in adjustment mode.
Shimano Di2	You can use Shimano® Di2™ electronic shifters to display shifting information during a ride. The Edge 840 device displays current adjustment values when the sensor is in adjustment mode.
Shimano STEPS	You can use your device with your Shimano STEPS™ eBike and view bike data, such as battery and shifting information, during your rides (Viewing eBike Sensor Details, page 48).
Smart Trainer	You can use your device with an indoor bike smart trainer to simulate resistance while following a course, ride, or workout (Using an Indoor Trainer, page 10).
Speed/ Cadence	You can attach speed or cadence sensors to your bike and view the data during your ride. If necessary, you can manually enter your wheel circumference (Wheel Size and Circumference, page 84).
Tempe	You can attach the tempe™ temperature sensor to a secure strap or loop where it is exposed to ambient air, so it provides a consistent source of accurate temperature data.
VIRB	The VIRB® remote function allows you to control your VIRB action camera using your device.

Putting On the Heart Rate Monitor

NOTE: If you do not have a heart rate monitor, you can skip this task.

You should wear the heart rate monitor directly on your skin, just below your sternum. It should be snug enough to stay in place during your activity.

- 1 Snap the heart rate monitor module **1** onto the strap.
The Garmin logos on the module and the strap should be right-side up.
- 2 Wet the electrodes **2** and the contact patches **3** on the back of the strap to create a strong connection between your chest and the transmitter.

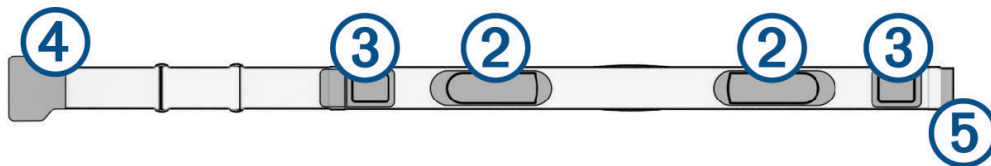

- 3 Wrap the strap around your chest, and connect the strap hook **4** to the loop **5**.
NOTE: The care tag should not fold over.

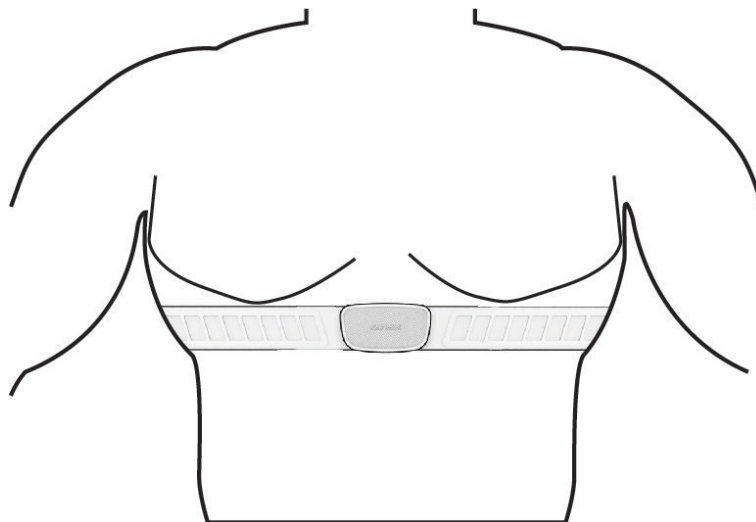

The Garmin logos should be right-side up.

- 4 Bring the device within 3 m (10 ft.) of the heart rate monitor.

After you put on the heart rate monitor, it is active and sending data.

TIP: If the heart rate data is erratic or does not appear, see the troubleshooting tips ([Tips for Erratic Heart Rate Data](#), page 42).

Setting Your Heart Rate Zones

The device uses your user profile information from the initial setup to determine your heart rate zones. You can manually adjust the heart rate zones according to your fitness goals ([Fitness Goals, page 42](#)). For the most accurate calorie data during your activity, you should set your maximum heart rate, resting heart rate, and heart rate zones.

- 1 Select  > **My Stats** > **Training Zones** > **Heart Rate Zones**.
- 2 Enter your maximum, lactate threshold, and resting heart rate values.
You can use the auto detect feature to automatically detect your heart rate during an activity. The zone values update automatically, but you can also edit each value manually.
- 3 Select **Based On:**.
- 4 Select an option:
 - Select **BPM** to view and edit the zones in beats per minute.
 - Select **% Max.** to view and edit the zones as a percentage of your maximum heart rate.
 - Select **% HRR** to view and edit the zones as a percentage of your heart rate reserve (maximum heart rate minus resting heart rate).
 - Select **%LTHR** to view and edit the zones as a percentage of your lactate threshold heart rate.

About Heart Rate Zones

Many athletes use heart rate zones to measure and increase their cardiovascular strength and improve their level of fitness. A heart rate zone is a set range of heartbeats per minute. The five commonly accepted heart rate zones are numbered from 1 to 5 according to increasing intensity. Generally, heart rate zones are calculated based on percentages of your maximum heart rate.

Fitness Goals

Knowing your heart rate zones can help you measure and improve your fitness by understanding and applying these principles.

- Your heart rate is a good measure of exercise intensity.
- Training in certain heart rate zones can help you improve cardiovascular capacity and strength.

If you know your maximum heart rate, you can use the table ([Heart Rate Zone Calculations, page 84](#)) to determine the best heart rate zone for your fitness objectives.

If you do not know your maximum heart rate, use one of the calculators available on the Internet. Some gyms and health centers can provide a test that measures maximum heart rate. The default maximum heart rate is 220 minus your age.

Tips for Erratic Heart Rate Data

If the heart rate data is erratic or does not appear, you can try these tips.

- Reapply water to the electrodes and contact patches (if applicable).
- Tighten the strap on your chest.
- Warm up for 5 to 10 minutes.
- Follow the care instructions ([Caring for the Heart Rate Monitor, page 67](#)).
- Wear a cotton shirt or thoroughly wet both sides of the strap.

Synthetic fabrics that rub or flap against the heart rate monitor can create static electricity that interferes with heart rate signals.

- Move away from sources that can interfere with your heart rate monitor.

Sources of interference may include strong electromagnetic fields, some 2.4 GHz wireless sensors, high-voltage power lines, electric motors, ovens, microwave ovens, 2.4 GHz cordless phones, and wireless LAN access points.

Installing the Speed Sensor

NOTE: If you do not have this sensor, you can skip this task.

TIP: Garmin recommends you secure your bike on a stand while installing the sensor.

- 1 Place and hold the speed sensor on top of the wheel hub.
- 2 Pull the strap ① around the wheel hub, and attach it to the hook ② on the sensor.

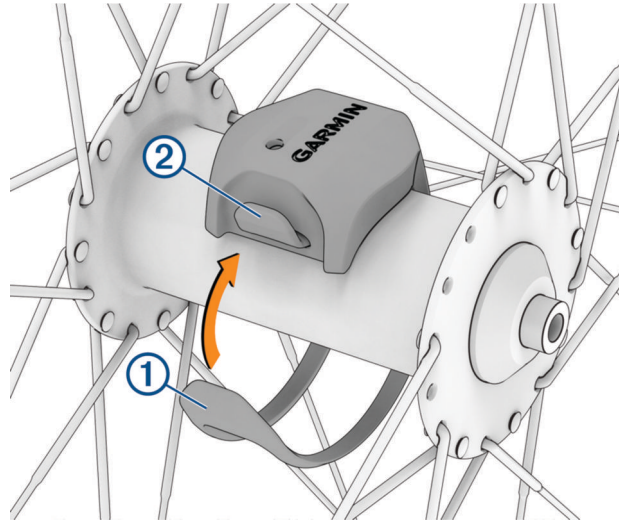

The sensor may be tilted when installed on an asymmetrical hub. This does not affect operation.

- 3 Rotate the wheel to check for clearance.
The sensor should not contact other parts of your bike.

NOTE: The LED flashes green for five seconds to indicate activity after two revolutions.

Installing the Cadence Sensor

NOTE: If you do not have this sensor, you can skip this task.

TIP: Garmin recommends you secure your bike on a stand while installing the sensor.

- 1 Select the band size that fits your crank arm ① securely.
The band you select should be the smallest one that stretches across the crank arm.
- 2 On the non-drive side, place and hold the flat side of the cadence sensor on the inside of the crank arm.
- 3 Pull the bands ② around the crank arm, and attach them to the hooks ③ on the sensor.

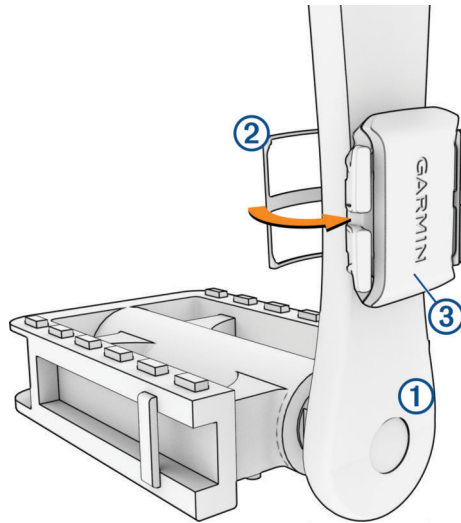

- 4 Rotate the crank arm to check for clearance.
The sensor and bands should not contact any part of your bike or shoe.
NOTE: The LED flashes green for five seconds to indicate activity after two revolutions.
- 5 Take a 15 minute test ride and inspect the sensor and bands to ensure there is no evidence of damage.

About the Speed and Cadence Sensors

Cadence data from the cadence sensor is always recorded. If no speed and cadence sensors are paired with the device, GPS data is used to calculate the speed and distance.

Cadence is your rate of pedaling or “spinning” measured by the number of revolutions of the crank arm per minute (rpm).

Data Averaging for Cadence or Power

The non-zero data-averaging setting is available if you are training with an optional cadence sensor or power meter. The default setting excludes zero values that occur when you are not pedaling.

You can change the value of this setting ([Data Recording Settings, page 59](#)).

Pairing Your Wireless Sensors

Before you can pair, you must put on the heart rate monitor or install the sensor.

The first time you connect a wireless sensor to your device using ANT+ or Bluetooth technology, you must pair the device and sensor. If the sensor has both ANT+ and Bluetooth technology, Garmin recommends that you pair using ANT+ technology. After they are paired, the Edge bike computer connects to the sensor automatically when you start an activity and the sensor is active and within range.

NOTE: If your device was packaged with a sensor, they are already paired.

1 Bring the device within 3 m (10 ft.) of the sensor.

NOTE: Stay 10 m (33 ft.) away from other riders' sensors while pairing.

2 Select  > **Sensors** > **Add Sensor**.

3 Select an option:

- Select a sensor type.
- Select **Search All** to search for all nearby sensors.

A list of available sensors appears.

4 Select one or more sensors to pair with your device.

5 Select **Add**.

When the sensor is paired with your device, the sensor status is Connected. You can customize a data field to display sensor data.

Wireless Sensor Battery Life

After you go for a ride, battery life levels for the wireless sensors that were connected during the activity appear. The list is sorted by battery level.

Training with Power Meters

- Go to www.garmin.com/intosports for a list of power meters that are compatible with your Edge bike computer (such as Rally and Vector systems).
- For more information, see the owner's manual for your power meter.
- Adjust your power zones to match your goals and abilities ([Setting Your Power Zones, page 45](#)).
- Use range alerts to be notified when you reach a specified power zone ([Setting Range Alerts, page 55](#)).
- Customize the power data fields ([Adding a Data Screen, page 54](#)).

Setting Your Power Zones

The values for the zones are default values and may not match your personal abilities. You can manually adjust your zones on the device or using Garmin Connect. If you know your functional threshold power (FTP) value, you can enter it and allow the software to calculate your power zones automatically.

1 Select  > **My Stats** > **Training Zones** > **Power Zones**.

2 Enter your FTP value.

3 Select **Based On:**.

4 Select an option:

- Select **watts** to view and edit the zones in watts.
- Select **% FTP** to view and edit the zones as a percentage of your functional threshold power.
- Select **Configuration** to edit the number of power zones.

Calibrating Your Power Meter

Before you can calibrate your power meter, you must install it, pair it with your device, and begin actively recording data with it.

For calibration instructions specific to your power meter, see the manufacturer's instructions.

- 1 Select  > **Sensors**.
- 2 Select your power meter.
- 3 Select **Calibrate**.
- 4 Keep your power meter active by pedaling until the message appears.
- 5 Follow the on-screen instructions.

Pedal-Based Power

Rally measures pedal-based power.

Rally measures the force you apply a few hundred times every second. Rally also measures your cadence or rotational pedaling speed. By measuring the force, the direction of force, the rotation of the crank arm, and time, Rally can determine power (watts). Because Rally independently measures left and right leg power, it reports your left-right power balance.

NOTE: The single-sensing Rally system does not provide left-right power balance.

Cycling Dynamics

Cycling dynamics metrics measure how you apply power throughout the pedal stroke, and where you apply power on the pedal, allowing you to understand your particular way of riding. Understanding how and where you produce power allows you to train more efficiently and evaluate your bike fit.

NOTE: You must have a compatible, dual sensing power meter connected using ANT+ technology to use cycling dynamics metrics.

For more information, go to www.garmin.com/performance-data.

Using Cycling Dynamics

Before you can use cycling dynamics, you must pair the power meter with your device using ANT+ technology ([Pairing Your Wireless Sensors, page 45](#)).

NOTE: Recording cycling dynamics uses additional device memory.

- 1 Go for a ride.
- 2 Scroll to the cycling dynamics screen to view your power phase data ①, total power ②, and platform center offset ③.

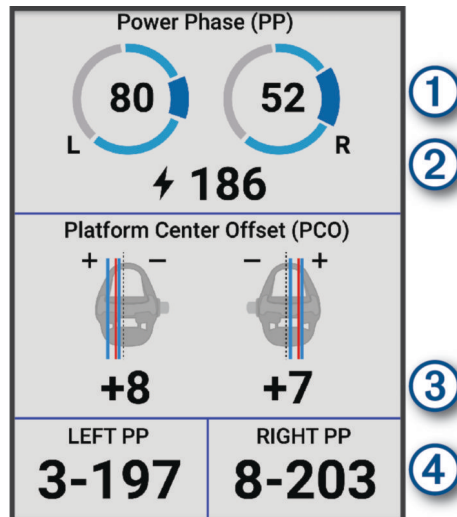

- 3 If necessary, hold a data field ④ to change it ([Adding a Data Screen, page 54](#)).

NOTE: The two data fields at the bottom of the screen can be customized.

You can send the ride to the Garmin Connect app to view additional cycling dynamics data ([Sending Your Ride to Garmin Connect, page 50](#)).

Power Phase Data

Power phase is the pedal stroke region (between the start crank angle and the end crank angle) where you produce positive power.

Platform Center Offset

Platform center offset is the location on the pedal platform where you apply force.

Customizing Cycling Dynamics Features

Before you can customize Rally features, you must pair a Rally power meter with your device.

- 1 Select  > **Sensors**.
- 2 Select the Rally power meter.
- 3 Select **Sensor Details** > **Cycling Dynamics**.
- 4 Select an option.
- 5 If necessary, select the toggle switches to turn on or off torque efficiency, pedal smoothness, and cycling dynamics.

Updating the Rally System Software Using the Edge Bike Computer

Before you can update the software, you must pair your Edge bike computer with your Rally system.

- 1 Send your ride data to your Garmin Connect account ([Sending Your Ride to Garmin Connect, page 50](#)).
Garmin Connect automatically looks for software updates and sends them to your Edge bike computer.
- 2 Bring your Edge bike computer within range (3 m) of the power meters.
- 3 Rotate the crank arm a few times. The Edge bike computer prompts you to install all pending software updates.
- 4 Follow the on-screen instructions.

Situational Awareness

⚠ WARNING

The Varia line of cycling awareness products can improve situational awareness. They are not a replacement for cyclist attentiveness and good judgment. Always maintain awareness of your surroundings, and operate the bicycle in a safe manner. Failure to do so could result in serious injury or death.



Your Edge bike computer can be used with the Varia line of cycling awareness products ([Wireless Sensors, page 40](#)). See the owner's manual for your accessory for more information.

Using the Varia Camera Controls

NOTICE

Some jurisdictions may prohibit or regulate the recording of video, audio, or photographs, or may require that all parties have knowledge of the recording and provide consent. It is your responsibility to know and follow all laws, regulations, and any other restrictions in jurisdictions where you plan to use this device.

Before you can use the Varia camera controls, you must pair the accessory with your bike computer ([Pairing Your Wireless Sensors, page 45](#)).

- 1 Swipe down from the top of the screen to open the widgets.
- 2 Scroll to the Varia camera controls widget, and select an option:
 - Select **Radar Camera** to view the camera settings.
 - Select  to take a photo.
 - Select  to save a clip.

Enabling the Green Threat Level Tone

Before you can enable the green threat level tone, you must pair the device with a compatible Varia rearview radar device and enable tones.

You can enable a tone that plays when your radar transitions to the green threat level.

- 1 Select  > **Sensors**.
- 2 Select your radar device.
- 3 Select **Sensor Details** > **Alert Settings**.
- 4 Select the **Green Threat Level Tone** toggle switch.



Using Electronic Shifters

Before you can use compatible electronic shifters, such as Shimano Di2 shifters, you must pair them with your Edge bike computer ([Pairing Your Wireless Sensors, page 45](#)). You can customize the optional data fields ([Adding a Data Screen, page 54](#)). The Edge bike computer displays current adjustment values when the shifters are in adjustment mode.

The Edge 840 Bike Computer and Your eBike

Before you can use a compatible eBike, such as a Shimano STEPS eBike, you must pair it with your Edge bike computer ([Pairing Your Wireless Sensors, page 45](#)). You can customize the optional eBike data screen and data fields ([Adding a Data Screen, page 54](#)).

Viewing eBike Sensor Details

- 1 Select  > **Sensors**.
 - 2 Select your eBike.
 - 3 Select an option:
 - To view eBike details, such as the odometer or travel distance, select **Sensor Details** > **eBike Details**.
 - To view eBike error messages, select .
- See the eBike owner's manual for more information.

inReach Remote

The inReach remote function allows you to control your inReach satellite communicator using your Edge bike computer. Go to buy.garmin.com for more information about compatible devices.

Using the inReach Remote

- 1 Turn on the inReach satellite communicator.
- 2 On your Edge bike computer, select  > **Sensors** > **Add Sensor** > **inReach**.
- 3 Select your inReach satellite communicator, and select **Add**.
- 4 From the home screen, swipe down, and swipe left or right to view the inReach remote widget.
- 5 Select an option:
 - To send a preset message, select **inReach Messages** > **Send Preset**, and select a message from the list.
 - To send a text message, select **inReach Messages** > **Start Conversation**, select the message contacts, and enter the message text or select a quick text option.
 - To view the timer and distance traveled during a tracking session, select **inReach Tracking** > **Start Tracking**.
 - To send an SOS message, select **SOS**.

NOTE: You should only use the SOS function in a real emergency situation.

History

History includes time, distance, calories, speed, lap data, elevation, and optional information about sensors using ANT+ technology.

NOTE: History is not recorded while the activity timer is stopped or paused.

When the device memory is full, a message appears. The device does not automatically delete or overwrite your history. Upload your history to your Garmin Connect account periodically to keep track of all your ride data.

Viewing Your Ride

- 1 Select **History** > **Rides**.
- 2 Select a ride.
- 3 Select an option.

Viewing Your Time in Each Training Zone

Before you can view your time in each training zone, you must pair your device with a compatible heart rate monitor or power meter, complete an activity, and save the activity.

Viewing your time in each heart rate and power zone can help you adjust your training intensity. You can adjust your power zones ([Setting Your Power Zones, page 45](#)) and your heart rate zones ([Setting Your Heart Rate Zones, page 42](#)) to match your goals and abilities. You can customize a data field to display your time in training zones during your ride ([Adding a Data Screen, page 54](#)).

- 1 Select **History** > **Rides**.
- 2 Select a ride.
- 3 Select **Summary**.
- 4 Select an option:
 - Select **HR Zones**.
 - Select **Power Zones**.

Deleting a Ride

- 1 Select **History** > **Rides**.
- 2 Swipe a ride to the left and select .

Viewing Data Totals

You can view the accumulated data you have saved to the device, including the number of rides, time, distance, and calories.

Select **History > Totals**.

Deleting Data Totals

1 Select **History > Totals**.

2 Select an option:

- Select  to delete all data totals from the history.
- Select an activity profile to delete accumulated data totals for a single profile.

NOTE: This does not delete any saved activities.

3 Select .

Garmin Connect

You can connect with your friends on Garmin Connect. Garmin Connect gives you the tools to track, analyze, share, and encourage each other. Record the events of your active lifestyle including runs, walks, rides, swims, hikes, triathlons, and more.

You can create your free Garmin Connect account when you pair your device with your phone using the Garmin Connect app, or you can go to connect.garmin.com.

Store your activities: After you complete and save an activity with your device, you can upload that activity to Garmin Connect and keep it as long as you want.

Analyze your data: You can view more detailed information about your activity, including time, distance, elevation, heart rate, calories burned, cadence, an overhead map view, pace and speed charts, and customizable reports.

NOTE: Some data requires an optional accessory such as a heart rate monitor.



Plan your training: You can choose a fitness goal and load one of the day-by-day training plans.

Share your activities: You can connect with friends to follow each other's activities or post links to your activities on your favorite social networking sites.

Sending Your Ride to Garmin Connect

- Sync your Edge bike computer with the Garmin Connect app on your phone.
- Use the USB cable that came with your Edge bike computer to send ride data to your Garmin Connect account on your computer.

Data Recording

The device records points every second. It records key points where you change direction, speed, or heart rate. Recording points every second provides an extremely detailed track and uses more of the available memory. For information about data averaging for cadence and power, see [Data Averaging for Cadence or Power](#), page 44.

Data Management

NOTE: The device is not compatible with Windows® 95, 98, Me, Windows NT®, and Mac® OS 10.3 and earlier.

Connecting the Device to Your Computer

NOTICE

To prevent corrosion, thoroughly dry the USB port, the weather cap, and the surrounding area before charging or connecting to a computer.

- 1 Pull up the weather cap from the USB port.
- 2 Plug one end of the cable into the USB port on the device.
- 3 Plug the other end of the cable into a computer USB port.
Your device appears as a removable drive in This PC on Windows computers and as an available disk on Mac computers.

Transferring Files to Your Device

- 1 Connect the device to your computer.
On Windows computers, the device appears as a removable drive or a portable device. On Mac computers, the device appears as a mounted volume.
NOTE: Some computers with multiple network drives may not display device drives properly. See your operating system documentation to learn how to map the drive.
- 2 On your computer, open the file browser.
- 3 Select a file.
- 4 Select **Edit > Copy**.
- 5 Open the portable device, drive, or volume for the device.
- 6 Browse to a folder.
- 7 Select **Edit > Paste**.
The file appears in the list of files in the device memory.

Deleting Files

NOTICE

If you do not know the purpose of a file, do not delete it. Your device memory contains important system files that should not be deleted.

- 1 Open the **Garmin** drive or volume.
- 2 If necessary, open a folder or volume.
- 3 Select a file.
- 4 Press the **Delete** key on your keyboard.
NOTE: If you are using an Apple® computer, you must empty the Trash folder to completely remove the files.

Disconnecting the USB Cable

If your device is connected to your computer as a removable drive or volume, you must safely disconnect your device from your computer to avoid data loss. If your device is connected to your Windows computer as a portable device, it is not necessary to safely disconnect the device.

- 1 Complete an action:
 - For Windows computers, select the **Safely Remove Hardware** icon in the system tray, and select your device.
 - For Apple computers, select the device, and select **File > Eject**.
- 2 Disconnect the cable from your computer.

Customizing Your Device

Connect IQ Downloadable Features

You can add Connect IQ features to your device from Garmin and other providers using the Connect IQ app.

Data Fields: Allow you to download new data fields that present sensor, activity, and history data in new ways.

You can add Connect IQ data fields to built-in features and pages.

Widgets: Provide information at a glance, including sensor data and notifications.

Apps: Add interactive features to your device, such as new outdoor and fitness activity types.

Downloading Connect IQ Features Using Your Computer

- 1 Connect the device to your computer using a USB cable.
- 2 Go to apps.garmin.com, and sign in.
- 3 Select a Connect IQ feature, and download it.
- 4 Follow the on-screen instructions.

Profiles

The Edge bike computer has several ways for you to customize the device, including profiles. Profiles are a collection of settings that optimize your device based on how you are using it. For example, you can create different settings and views for training and mountain biking.

When you are using a profile and you change settings such as data fields or units of measurement, the changes are saved automatically as part of the profile.

Activity Profiles: You can create activity profiles for each type of biking. For example, you can create a separate activity profile for training, for racing, and for mountain biking. The activity profile includes customized data pages, activity totals, alerts, training zones (such as heart rate and speed), training settings (such as Auto Pause® and Auto Lap® features), and navigation settings.

TIP: When you sync, activity profiles are saved in your Garmin Connect account and can be sent to your device at any time.

User Profile: You can update your sex, age, weight, and height settings. The device uses this information to calculate accurate ride data.

Setting Up Your User Profile

You can update your sex, age, weight, and height settings. The device uses this information to calculate accurate ride data.

- 1 Select  > **My Stats > User Profile**.
- 2 Select an option.

Gender Settings

When you first set up the device, you must choose a sex. Most fitness and training algorithms are binary. For the most accurate results, Garmin recommends selecting your sex assigned at birth. After the initial setup, you can customize the profile settings in your Garmin Connect account.

Profile & Privacy: Enables you to customize the data on your public profile.

User Settings: Sets your sex. If you select Not Specified, the algorithms that require a binary input will use the sex you specified when you first set up the device.

Training Settings

The following options and settings allow you to customize your device based on your training needs. These settings are saved to an activity profile. For example, you can set time alerts for your road profile and you can set an Auto Lap position trigger for your mountain biking profile.

TIP: You can also customize the activity profiles from the device settings in the Garmin Connect app.

Select  > **Activity Profiles**, and select a profile.

Alerts and Prompts: Sets how laps are triggered, and customizes the training or navigation alerts for the activity ([Alerts and Prompts Settings, page 55](#)).

Auto Sleep: Enables the device to automatically enter sleep mode after five minutes of inactivity ([Using Auto Sleep, page 57](#)).

Climbs: Enables the ClimbPro feature and sets which types of climbs the device detects ([Using ClimbPro, page 31](#)).

Data Screens: Enables you to customize data screens and add new data screens for the activity ([Adding a Data Screen, page 54](#)).

MTB/CX: Enables grit, flow, and jump recording.

Navigation: Sets navigation messages, and customizes the map and routing settings ([Map Settings, page 32](#)) ([Route Settings, page 33](#)).

Nutrition/Hydration: Enables food and drink consumption tracking.

Satellite Systems: Allows you to turn off GPS ([Training Indoors, page 10](#)), or set the satellite system to use for the activity ([Changing the Satellite Setting, page 58](#)).

Segments: Turns on your enabled segments ([Enabling Segments, page 9](#)).

Self Evaluation: Sets how often you evaluate your perceived effort for the activity ([Evaluating an Activity, page 3](#)).

Timer: Sets timer preferences. The Auto Pause option allows you to set when the activity timer automatically pauses ([Using Auto Pause, page 57](#)). The Timer Start Mode option enables you to set how the device detects the start of a ride and automatically starts the activity timer ([Starting the Timer Automatically, page 58](#)).

Updating Your Activity Profile

You can customize your activity profiles. You can customize your settings and data fields for a particular activity or trip ([Training Settings, page 53](#)).

TIP: You can also customize the activity profiles from the device settings in the Garmin Connect app.

1 Select  > **Activity Profiles**.







2 Select an option:

- Select a profile.
- Select **Create New** to add or copy a profile.





3 If necessary, select  to edit the name, color, and default ride type for the profile.

TIP: After a ride that is not typical, you can manually update the ride type. Accurate ride type data is important for creating bike friendly courses.





Adding a Data Screen

- 1 Select  > **Activity Profiles**.
- 2 Select a profile.
- 3 Select **Data Screens** > **Add Data Screen** > **Data Screen**.
- 4 Select a category, and select one or more data fields.
TIP: For a list of all the available data fields, go to ([Data Fields, page 75](#)).
- 5 Select .
- 6 Select an option:
 - Select another category to select more data fields.
 - Select .
- 7 Select  or  to change the layout.
- 8 Select .
- 9 Select an option:
 - Tap a data field, then tap another data field to rearrange them.
 - Double-tap a data field to change it.
- 10 Select .

Editing a Data Screen

- 1 Select  > **Activity Profiles**.
- 2 Select a profile.
- 3 Select **Data Screens**.
- 4 Select a data screen.
- 5 Select **Layout and Data Fields**.
- 6 Select  or  to change the layout.
- 7 Select .
- 8 Select an option:
 - Tap a data field, then tap another data field to rearrange them.
 - Double-tap a data field to change it.
- 9 Select .

Rearranging Data Screens

- 1 Select  > **Activity Profiles**.
- 2 Select a profile.
- 3 Select **Data Screens** >  > **Reorder**.
- 4 Hold  on a data screen and drag it to a new location.
- 5 Select .

Alerts and Prompts Settings

You can use alerts to train toward specific time, distance, calorie, heart rate, cadence, and power goals. You can also set up navigation alerts. Alert settings are saved with your activity profile ([Training Settings, page 53](#)).

Select  > **Activity Profiles**, select a profile, and select **Alerts and Prompts**.

Sharp Bend Warnings: Enables safety warning messages for difficult turns.

High Traffic Road Warnings: Enables safety warning messages for high traffic areas.

Workout Target Alerts: Enables an alert when you reach a target during your workout.

Lap: Sets how laps are triggered ([Marking Laps by Position, page 56](#)).

Time Alert: Sets an alert for a specified time ([Setting Recurring Alerts, page 55](#)).

Distance Alert: Sets an alert for a specified distance ([Setting Recurring Alerts, page 55](#)).

Calorie Alert: Sets an alert when you have burned a specified number of calories.

Heart Rate Alert: Sets the device to alert you when your heart rate is above or below a target zone ([Setting Range Alerts, page 55](#)).

Cadence Alert: Sets the device to alert you when your cadence is above or below a custom range of reps per minute ([Setting Range Alerts, page 55](#)).

Power Alert: Sets the device to alert you when your power threshold is above or below a target zone ([Setting Range Alerts, page 55](#)).

Turn Around Alert: Sets an alert to indicate when you should turn around during your ride.

Eat Alert: Sets an alert to notify you to eat at a specified time, distance, or strategic interval during your ride ([Setting Smart Eat and Drink Alerts, page 56](#)).

Drink Alert: Sets an alert to notify you to drink at a specified time, distance, or strategic interval during your ride ([Setting Smart Eat and Drink Alerts, page 56](#)).

Connect IQ Alerts: Enables alerts that have been set up in Connect IQ apps.

Setting Range Alerts



If you have an optional heart rate monitor, cadence sensor, or power meter, you can set up range alerts. A range alert notifies you when the device measurement is above or below a specified range of values. For example, you can set the device to alert you when your cadence is below 40 RPM and over 90 RPM. You can also use a training zone for the range alert ([Training Zones, page 25](#)).

- 1 Select  > **Activity Profiles**.
- 2 Select a profile.
- 3 Select **Alerts and Prompts**.
- 4 Select **Heart Rate Alert**, **Cadence Alert**, or **Power Alert**.
- 5 Select the minimum and maximum values, or select zones.

Each time you exceed or drop below the specified range, a message appears. The device also beeps if audible tones are turned on ([Turning the Device Tones On and Off, page 60](#)).

Setting Recurring Alerts

A recurring alert notifies you each time the device records a specified value or interval. For example, you can set the device to alert you every 30 minutes.

- 1 Select  > **Activity Profiles**.
- 2 Select a profile.
- 3 Select **Alerts and Prompts**.
- 4 Select an alert type.
- 5 Turn on the alert.
- 6 Enter a value.
- 7 Select .

Each time you reach the alert value, a message appears. The device also beeps if audible tones are turned on ([Turning the Device Tones On and Off, page 60](#)).

Setting Smart Eat and Drink Alerts

A smart alert notifies you to eat or drink at strategic intervals based on current ride conditions. Smart alert estimates for a ride are based on the temperature, elevation gain, speed, duration, and heart rate and power data (if applicable).





- 1 Select  > **Activity Profiles**.
- 2 Select a profile.
- 3 Select **Alerts and Prompts**.
- 4 Select **Eat Alert** or **Drink Alert**.
- 5 Turn on the alert.
- 6 Select **Type** > **Smart**.

Each time you reach the estimated smart alert value, a message appears. The device also beeps if audible tones are turned on ([Turning the Device Tones On and Off, page 60](#)).

Auto Lap



Marking Laps by Position

You can use the Auto Lap feature to mark the lap at a specific position automatically. This feature is helpful for comparing your performance over different parts of a ride (for example, a long climb or training sprints). During courses, you can use the By Position option to trigger laps at all of the lap positions saved in the course.

- 1 Select  > **Activity Profiles**.
- 2 Select a profile.
- 3 Select **Alerts and Prompts** > **Lap**.
- 4 Turn on the **Auto Lap** alert.
- 5 Select **Auto Lap Trigger** > **By Position**.
- 6 Select **Lap At**.
- 7 Select an option:
 - Select **Lap Press Only** to trigger the lap counter each time you press  and each time you pass any of those locations again.
 - Select **Start and Lap** to trigger the lap counter at the GPS location where you press  and at any location during the ride where you press .
 - Select **Mark and Lap** to trigger the lap counter at a specific GPS location marked before the ride and at any location during the ride where you press .
- 8 If necessary, customize the lap data fields ([Adding a Data Screen, page 54](#)).





Marking Laps by Distance

You can use the Auto Lap feature to mark the lap at a specific distance automatically. This feature is helpful for comparing your performance over different parts of a ride (for example, every 10 miles or 40 kilometers).

- 1 Select  > **Activity Profiles**.
- 2 Select a profile.
- 3 Select **Alerts and Prompts** > **Lap**.
- 4 Turn on the **Auto Lap** alert.
- 5 Select **Auto Lap Trigger** > **By Distance**.
- 6 Select **Lap At**.
- 7 Enter a value.
- 8 Select .
- 9 If necessary, customize the lap data fields ([Adding a Data Screen, page 54](#)).

Marking Laps by Time

You can use the Auto Lap feature to mark the lap at a specific time automatically. This feature is helpful for comparing your performance over different parts of a ride (for example, every 20 minutes).

- 1 Select  > **Activity Profiles**.
- 2 Select a profile.
- 3 Select **Alerts and Prompts > Lap**.
- 4 Turn on the **Auto Lap** alert.
- 5 Select **Auto Lap Trigger > By Time**.
- 6 Select **Lap At**.
- 7 Select the hours, minutes, or seconds value.
- 8 Select  or  to enter a value.
- 9 Select .
- 10 If necessary, customize the lap data fields ([Adding a Data Screen, page 54](#)).

Customizing the Lap Banner

You can customize the data fields that appear in the lap banner.

- 1 Select  > **Activity Profiles**.
- 2 Select a profile.
- 3 Select **Alerts and Prompts > Lap**.
- 4 Turn on the **Auto Lap** alert.
- 5 Select **Custom Lap Banner**.
- 6 Select a data field to change it.

Using Auto Sleep

You can use the Auto Sleep feature to automatically enter sleep mode after 5 minutes of inactivity. During sleep mode, the screen is turned off and sensors, Bluetooth technology, and GPS are disabled.

Wi-Fi continues to run while the device is asleep.

- 1 Select  > **Activity Profiles**.
- 2 Select a profile.
- 3 Select **Auto Sleep**.

Using Auto Pause



You can use the Auto Pause feature to pause the timer automatically when you stop moving or when your speed drops below a specified value. This feature is helpful if your ride includes stop lights or other places where you need to slow down or stop.

NOTE: History is not recorded while the activity timer is stopped or paused.

- 1 Select  > **Activity Profiles**.
- 2 Select a profile.
- 3 Select **Timer > Auto Pause**.
- 4 Select an option:
 - Select **When Stopped** to pause the timer automatically when you stop moving.
 - Select **Custom** to pause the timer automatically when your speed drops below a specified value.
- 5 If necessary, customize optional time data fields ([Adding a Data Screen, page 54](#)).



Using Auto Scroll

You can use the Auto Scroll feature to automatically cycle through all of the training data screens while the timer is running.

- 1 Select  > **Activity Profiles**.
- 2 Select a profile.
- 3 Select **Data Screens** >  > **Auto Scroll**.
- 4 Select a display speed.

Starting the Timer Automatically

This feature automatically detects when your device has acquired satellites and is moving. It starts the activity timer or reminds you to start the activity timer so you can record your ride data.

- 1 Select  > **Activity Profiles**.
- 2 Select a profile.
- 3 Select **Timer** > **Timer Start Mode**.
- 4 Select an option:
 - Select **Manual**, and select  to start the activity timer.
 - Select **Prompted** to display a visual reminder when you reach the start notice speed.
 - Select **Auto** to start the activity timer automatically when you reach the start speed.

Changing the Satellite Setting

Using GPS and another satellite together reduces battery life more quickly than using only GPS.

- 1 Select  > **Activity Profiles**.
- 2 Select a profile.
- 3 Select **Satellite Systems**.
- 4 Select an option.

Phone Settings

Select  > **Connected Features** > **Phone**.

Enable: Enables Bluetooth.

NOTE: Other Bluetooth settings appear only when you enable Bluetooth technology.

Friendly Name: Allows you to enter a friendly name that identifies your devices with Bluetooth.

Pair Smartphone: Connects your device with a compatible Bluetooth enabled phone. This setting allows you to use Bluetooth connected features, including LiveTrack and activity uploads to Garmin Connect.

Sync Now: Allows you to sync your device with your compatible phone.

Smart Notifications: Allows you to enable phone notifications from your compatible phone.

Missed Notifications: Displays missed phone notifications from your compatible phone.

Text Reply Signature: Enables signatures in your text message replies. This feature is available with compatible Android phones.

System Settings

Select  > **System**.

- Display Settings ([Display Settings, page 59](#))
- Widget Settings ([Customizing the Widget Loop, page 59](#))
- Data Recording Settings ([Data Recording Settings, page 59](#))
- Unit Settings ([Changing the Units of Measure, page 59](#))
- Tone Settings ([Turning the Device Tones On and Off, page 60](#))
- Language Settings ([Changing the Device Language, page 60](#))

Display Settings

Select  > **System** > **Display**.

Auto Brightness: Automatically adjusts the backlight brightness based on the ambient light.

Brightness: Sets the backlight brightness.

Backlight Timeout: Sets the length of time before the backlight turns off.

Color Mode: Sets the device to display day or night colors. You can select the Auto option to allow the device to set day or night colors automatically based on the time of day.

Screen Capture: Allows you to save the image on the device screen when you press .



Using the Backlight

You can tap the touchscreen to turn on the backlight.

NOTE: You can adjust the backlight timeout ([Display Settings, page 59](#)).



- 1 From the home screen or a data screen, swipe down from the top of the screen.
- 2 Select an option:
 - To manually adjust the brightness, select , and use the slider bar.
 - To allow the device to automatically adjust the brightness based on the ambient light, select **Auto**.

Customizing the Glances

- 1 Scroll to the bottom of the home screen.
- 2 Select .
- 3 Select an option:
 - Select **Add Glances** to add a glance to the glance loop.
 - Select  to drag the glance up or down to change the location of the glance in the glance loop.
 - Swipe left on a glance, and select  to remove the glance from the glance loop.

Customizing the Widget Loop

You can change the order of widgets in the widget loop, remove widgets, and add new widgets.

- 1 Select  > **System** > **Widgets**.
- 2 Select an option:
 - Select **Add Widgets** to add a widget to the widget loop.
 - Select  to drag the widget up or down to change the location of the widget in the widget loop.
 - Swipe left on a widget, and select  to remove the widget from the widget loop.

Data Recording Settings

Select  > **System** > **Data Recording**.

Cadence Averaging: Controls whether the device includes zero values for cadence data that occur when you are not pedaling ([Data Averaging for Cadence or Power, page 44](#)).

Power Averaging: Controls whether the device includes zero values for power data that occur when you are not pedaling ([Data Averaging for Cadence or Power, page 44](#)).

Log HRV: Sets the device to record your heart rate variability during an activity.

Changing the Units of Measure

You can customize units of measure for distance and speed, elevation, temperature, weight, position format, and time format.

- 1 Select  > **System** > **Units**.
- 2 Select a measurement type.
- 3 Select a unit of measure for the setting.

Turning the Device Tones On and Off

Select  > **System** > **Tones**.

Changing the Device Language

Select  > **System** > **Language**.

Time Zones

Each time you turn on the device and acquire satellites or sync with your phone, the device automatically detects your time zone and the current time of day.

Setting Up Extended Display Mode

You can use your Edge 840 bike computer as an extended display to view data screens from a compatible Garmin multisport watch. For example, you can pair a compatible Forerunner watch to display its data screens on your Edge bike computer during a triathlon.

- 1 From your Edge bike computer, select  > **Extended Display** > **Connect Watch**.
- 2 From your compatible Garmin watch, select **Settings** > **Sensors & Accessories** > **Add New** > **Extended Display** > **Connect Watch**.
- 3 Follow the on-screen instructions on your Edge bike computer and Garmin watch to complete the pairing process.

The data screens from your paired watch appear on the Edge bike computer when the devices are paired.

NOTE: Normal Edge functions are disabled while using Extended Display mode.

After pairing your compatible Garmin watch with your Edge bike computer, they connect automatically the next time you use Extended Display mode.

Exiting Extended Display Mode

While the device is in Extended Display mode, tap the screen, and select **Exit Extended Display Mode** > **Yes**.

Device Information

Charging the Device

NOTICE

To prevent corrosion, thoroughly dry the USB port, the weather cap, and the surrounding area before charging or connecting to a computer.

NOTE: The device will not charge when outside the approved temperature range (*Edge Specifications*, page 66).

- 1 Pull up the weather cap ① from the USB port ②.

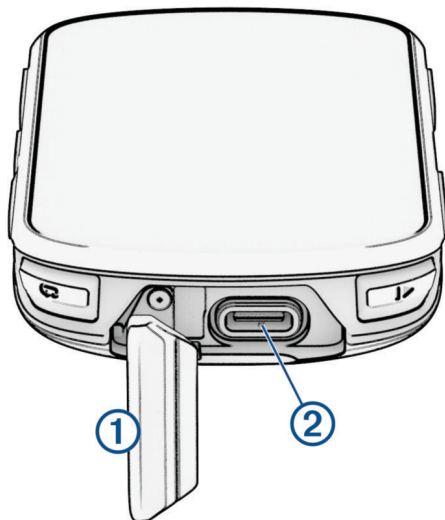

- 2 Plug the cable into the charging port on the device.
- 3 Plug the other end of the cable into a USB charging port.
When you connect the device to a power source, the device turns on.
- 4 Charge the device completely.

After you charge the device, close the weather cap.

About the Battery

⚠ WARNING

This device contains a lithium-ion battery. See the *Important Safety and Product Information* guide in the product box for product warnings and other important information.

Installing the Standard Mount

For the best GPS reception and screen visibility, position the bike mount so the device is horizontal to the ground and the front of the device is oriented toward the sky. You can install the bike mount on the stem or the handlebar.

NOTE: If you do not have this mount, you can skip this task.

- 1 Select a secure location to mount the device where it does not interfere with the safe operation of your bike.
- 2 Place the rubber disk ① on the back of the bike mount.

Two rubber disks are included, and you can select the disk that best fits your bike. The rubber tabs align with the back of the bike mount so it stays in place.

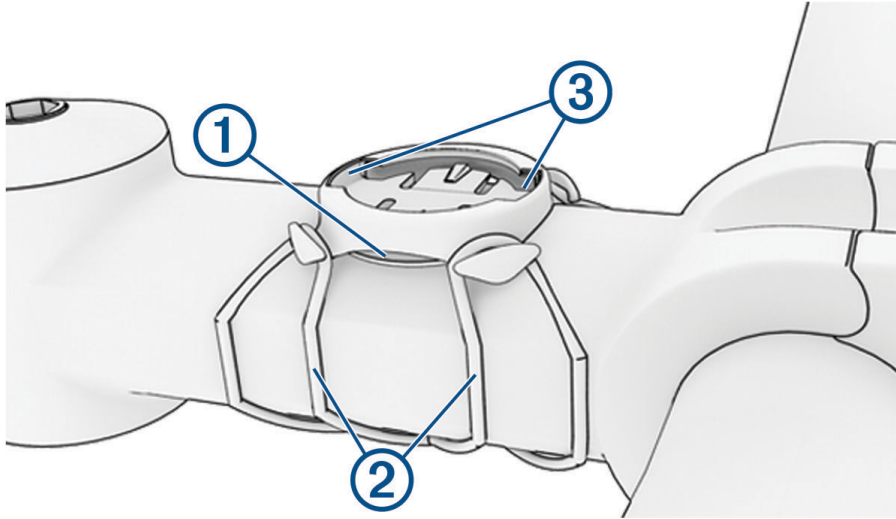

- 3 Place the bike mount on the bike stem.
- 4 Attach the bike mount securely using the two bands ②.
- 5 Align the tabs on the back of the device with the bike mount notches ③.
- 6 Press down slightly and turn the device clockwise until it locks into place.

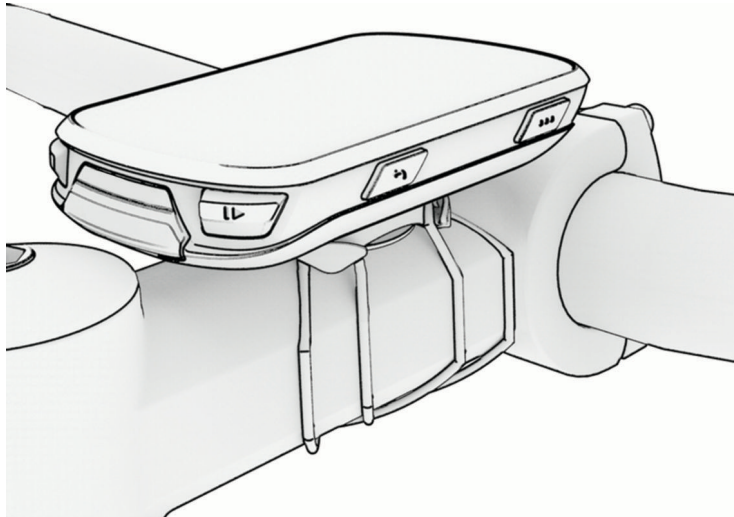

Installing the Out-Front Mount

NOTE: If you do not have this mount, you can skip this task.

- 1 Select a secure location to mount the Edge bike computer where it does not interfere with the safe operation of your bike.
- 2 Use the hex key to remove the screw ① from the handlebar connector ②.

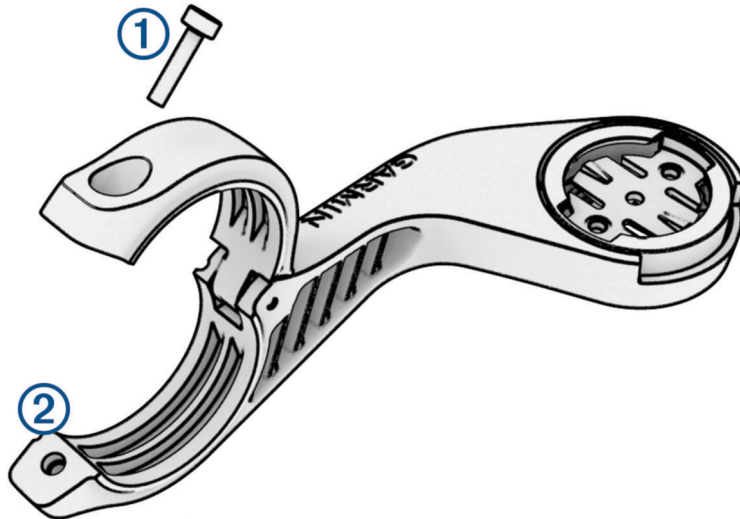

- 3 Place the rubber pad around the handlebar:
 - If the handlebar diameter is 25.4 mm or 26 mm, use the thicker pad.
 - If the handlebar diameter is 31.8 mm, use the thinner pad.
 - If the handlebar diameter is 35 mm, do not use a rubber pad.
- 4 Place the handlebar connector around the rubber pad.
- 5 Replace and tighten the screw.

NOTE: Garmin recommends tightening the screw so the mount is secure, with a maximum torque specification of 7 lbf-in. (0.8 N-m). You should check the tightness of the screw periodically.

- 6 Align the tabs on the back of the Edge bike computer with the bike mount notches ③.

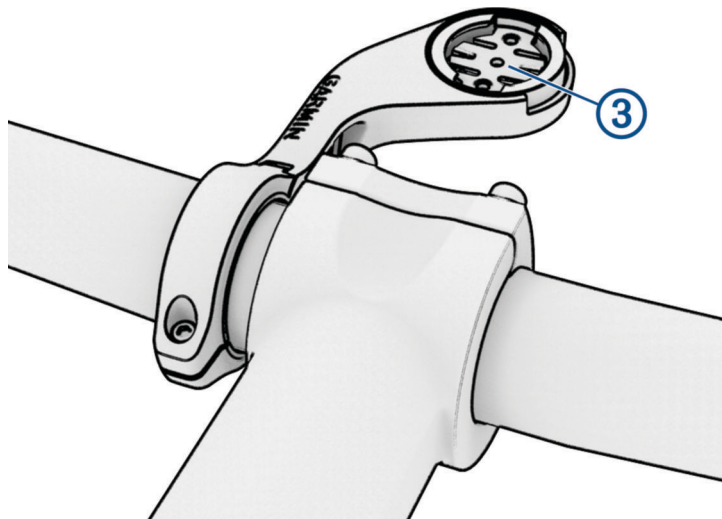

- 7 Press down slightly and turn the Edge bike computer clockwise until it locks into place.

Releasing the Edge

- 1 Turn the Edge clockwise to unlock the device.
- 2 Lift the Edge off the mount.

Installing the Mountain Bike Mount

NOTE: If you do not have this mount, you can skip this task.

- 1 Select a secure location to mount the Edge device where it does not interfere with the safe operation of your bike.
- 2 Use the 3 mm hex key to remove the screw ① from the handlebar connector ②.

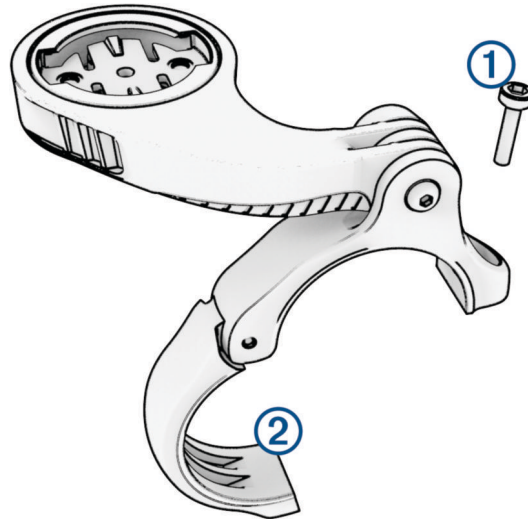

- 3 Select an option:
 - If the handlebar diameter is 25.4 mm or 26 mm, place the thicker pad around the handlebar.
 - If the handlebar diameter is 31.8 mm, place the thinner pad around the handlebar.
 - If the handlebar diameter is 35 mm, do not use a rubber pad.
- 4 Place the handlebar connector around the handlebar, so that the mount arm is above the bike stem.
- 5 Use the 3 mm hex key to loosen the screw ③ on the mount arm, position the mount arm, and tighten the screw.

NOTE: Garmin recommends tightening the screw so the mount arm is secure, with a maximum torque specification of 20 lbf-in. (2.26 N-m). You should check the tightness of the screw periodically.

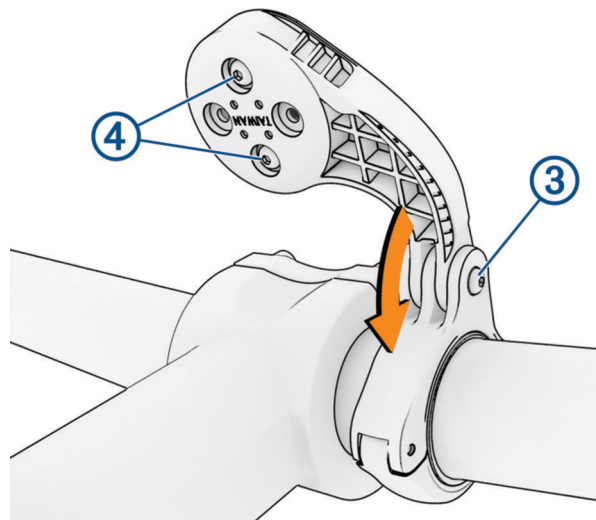

- 6 If necessary, use the 2 mm hex key to remove the two screws on the back side of the mount ④, remove and rotate the connector, and replace the screws to change the orientation of the mount.
- 7 Replace and tighten the screw on the handlebar connector.

NOTE: Garmin recommends tightening the screw so the mount is secure, with a maximum torque specification of 7 lbf-in. (0.8 N-m). You should check the tightness of the screw periodically.

- 8 Align the tabs on the back of the Edge device with the bike mount notches ⑤.

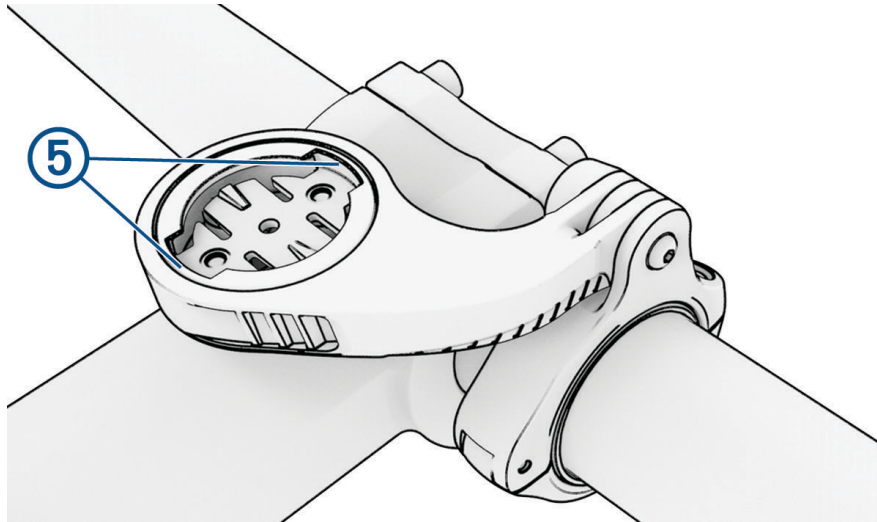

- 9 Press down slightly and turn the Edge device clockwise until it locks into place.

Product Updates

Your device automatically checks for updates when connected to Bluetooth or Wi-Fi. You can manually check for updates from the system settings ([System Settings, page 58](#)). On your computer, install Garmin Express (www.garmin.com/express). On your phone, install the Garmin Connect app.

This provides easy access to these services for Garmin devices:

- Software updates
- Map updates
- Data uploads to Garmin Connect
- Product registration

Updating the Software Using the Garmin Connect App

Before you can update your device software using the Garmin Connect app, you must have a Garmin Connect account, and you must pair the device with a compatible phone ([Pairing Your Phone, page 34](#)).

Sync your device with the Garmin Connect app.

When new software is available, the Garmin Connect app automatically sends the update to your device.

Updating the Software Using Garmin Express

Before you can update your device software, you must have a Garmin Connect account, and you must download the Garmin Express application.

- 1 Connect the device to your computer using the USB cable.
When new software is available, Garmin Express sends it to your device.
- 2 Follow the on-screen instructions.
- 3 Do not disconnect your device from the computer during the update process.

NOTE: If you have already set up your device with Wi-Fi connectivity, Garmin Connect can automatically download available software updates to your device when it connects using Wi-Fi.

Specifications

Edge Specifications

Battery type	Rechargeable, built-in lithium-ion battery
Battery life	Edge 840 : Up to 26 hr. Edge 840 Solar: Up to 32 hr. with solar ¹
Operating temperature range	From -20° to 60°C (from -4° to 140°F)
Charging temperature range	From 0° to 45°C (from 32° to 113°F)
Wireless frequencies	2.4 GHz @ 19.5 dBm maximum
Water rating	IEC 60529 IPX7 ²

HRM-Dual Specifications

Battery type	User-replaceable CR2032, 3 V
Battery life	Up to 3.5 yr. at 1 hr./day
Operating temperature range	From 0° to 40°C (from 32° to 104°F)
Wireless frequency	2.4 GHz @ 2 dBm maximum
Water rating	1 ATM ³ NOTE: This product does not transmit heart rate data while swimming.

Speed Sensor 2 and Cadence Sensor 2 Specifications

Battery type	User-replaceable CR2032, 3 V
Battery life	Approximately 12 mo. at 1 hr./day
Speed sensor storage	Up to 300 hr. of activity data
Operating temperature range	From -20° to 60°C (from -4° to 140°F)
Wireless frequency	2.4 GHz @ 4 dBm maximum
Water rating	IEC 60529 IPX7 ²

Viewing Device Information

You can view device information, such as the unit ID, software version, and license agreement.

Select  > **System** > **About** > **Copyright Info**.

Viewing Regulatory and Compliance Information

The label for this device is provided electronically. The e-label may provide regulatory information, such as identification numbers provided by the FCC or regional compliance markings, as well as applicable product and licensing information.

1 Select .

2 Select **System** > **Regulatory Info**.

¹ With use in 75,000 lux conditions

² The device withstands incidental exposure to water of up to 1 m for up to 30 min. For more information, go to www.garmin.com/waterrating.

³ The device withstands pressure equivalent to a depth of 10 m. For more information, go to www.garmin.com/waterrating.

Device Care

NOTICE

Do not store the device where prolonged exposure to extreme temperatures can occur, because it can cause permanent damage.

Never use a hard or sharp object to operate the touchscreen, or damage may result.

Avoid chemical cleaners, solvents, sunscreen, and insect repellents that can damage plastic components and finishes.

Secure the weather cap tightly to prevent damage to the USB port.

Avoid extreme shock and harsh treatment, because it can degrade the life of the product.

Cleaning the Device

NOTICE

Even small amounts of sweat or moisture can cause corrosion of the electrical contacts when connected to a charger. Corrosion can prevent charging and data transfer.

1 Wipe the device using a cloth dampened with a mild detergent solution.

2 Wipe it dry.

After cleaning, allow the device to dry completely.

Caring for the Heart Rate Monitor

NOTICE

You must unsnap and remove the module before washing the strap.

A build up of sweat and salt on the strap can decrease the ability of the heart rate monitor to report accurate data.

- Go to www.garmin.com/HRMcare for detailed washing instructions.
- Rinse the strap after every use.
- Machine wash the strap after every seven uses.
- Do not put the strap in a dryer.
- When drying the strap, hang it up or lay it flat.
- To prolong the life of your heart rate monitor, unsnap the module when not in use.

User Replaceable Batteries

WARNING

See the *Important Safety and Product Information* guide in the product box for product warnings and other important information.

Replacing the HRM-Dual Battery

- 1 Use the included screwdriver (Torx T5) to remove the four screws on the back of the module.
NOTE: HRM-Dual accessories produced before September 2020 use Phillips #00 screws.
- 2 Remove the cover and battery.

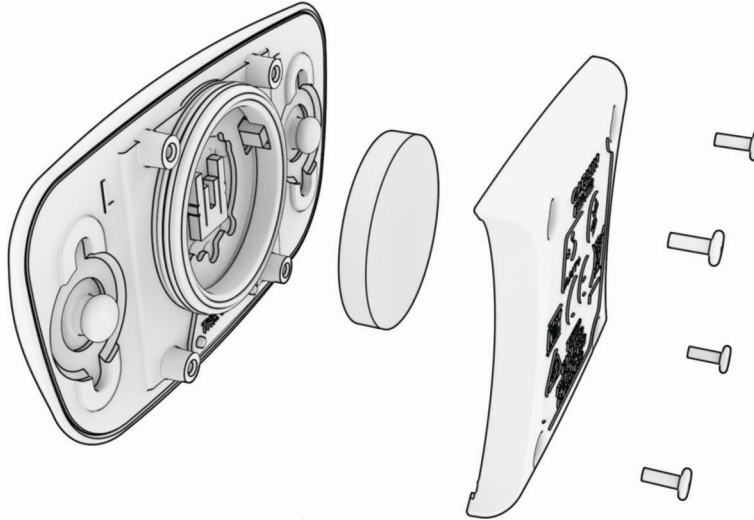

- 3 Wait 30 seconds.
- 4 Insert the new battery with the positive side facing up.
NOTE: Do not damage or lose the O-ring gasket.
- 5 Replace the back cover and the four screws.
NOTE: Do not overtighten.

After you replace the heart rate monitor battery, you may need to pair it with the device again.

Replacing the Speed Sensor Battery

The device uses one CR2032 battery. The LED flashes red to indicate a low battery level after two revolutions.

- 1 Locate the circular battery cover ① on the front of the sensor.

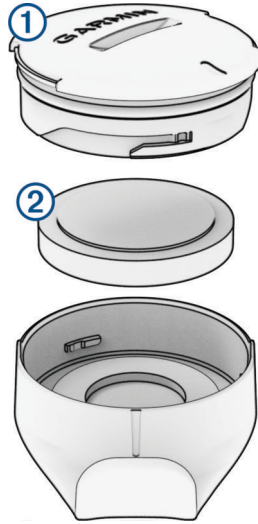

- 2 Twist the cover counter-clockwise until the cover is loose enough to remove.
- 3 Remove the cover and the battery ②.
- 4 Wait 30 seconds.
- 5 Insert the new battery into the cover, observing polarity.
NOTE: Do not damage or lose the O-ring gasket.
- 6 Twist the cover clockwise so that the marker on the cover aligns with the marker on the case.
NOTE: The LED flashes red and green for a few seconds after battery replacement. When the LED flashes green and then stops flashing, the device is active and ready to send data.

Replacing the Cadence Sensor Battery

The device uses one CR2032 battery. The LED flashes red to indicate a low battery level after two revolutions.

- 1 Locate the circular battery cover ① on the back of the sensor.

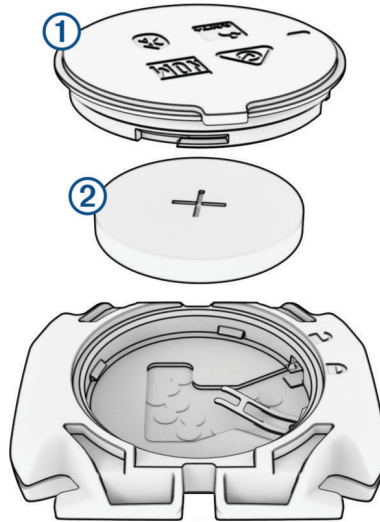

- 2 Twist the cover counter-clockwise until the marker points to unlocked and the cover is loose enough to remove.

- 3 Remove the cover and the battery ②.

- 4 Wait 30 seconds.

- 5 Insert the new battery into the cover, observing polarity.

NOTE: Do not damage or lose the O-ring gasket.

- 6 Twist the cover clockwise until the marker points to locked.

NOTE: The LED flashes red and green for a few seconds after battery replacement. When the LED flashes green and then stops flashing, the device is active and ready to send data.

Replacing the Cadence Sensor Battery

NOTE: Use these instructions for product models that have a coin slot on the battery door.

The device uses one CR2032 battery. The LED flashes red to indicate a low battery level after two revolutions.

- 1 Locate the circular battery cover ① on the back of the sensor.

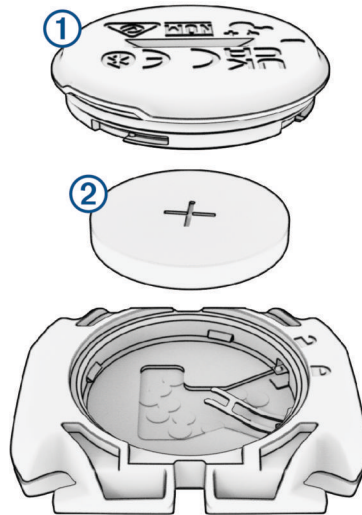

- 2 Twist the cover counter-clockwise until the marker points to unlocked and the cover is loose enough to remove.
- 3 Remove the cover and the battery ②.
- 4 Wait 30 seconds.
- 5 Insert the new battery into the cover, observing polarity.
NOTE: Do not damage or lose the O-ring gasket.
- 6 Twist the cover clockwise until the marker points to locked.
NOTE: The LED flashes red and green for a few seconds after battery replacement. When the LED flashes green and then stops flashing, the device is active and ready to send data.

Troubleshooting

Resetting the Device

If the device stops responding, you may need to reset it. This does not erase any of your data or settings.

Hold  for 10 seconds.

The device resets and turns on.



Restoring the Default Settings

You can restore the default configuration settings and activity profiles. This will not remove your history or activity data, such as rides, workouts, and courses.

Select  > **System** > **Device Reset** > **Reset Default Settings** > .

Clearing User Data and Settings

You can clear all user data and restore the device to its initial setup. This removes your history and data, such as rides, workouts, and courses, and resets the device settings and activity profiles. This will not remove any files you added to the device from your computer.

Select  > **System** > **Device Reset** > **Delete Data and Reset Settings** > .

Maximizing Battery Life

- Turn on **Battery Saver** (*Turning On Battery Saver Mode, page 72*).
- Decrease the backlight brightness or shorten the backlight timeout (*Display Settings, page 59*).
- Turn on the **Auto Sleep** feature (*Using Auto Sleep, page 57*).
- Turn off the **Phone** wireless feature (*Phone Settings, page 58*).
- Select the **GPS** setting (*Changing the Satellite Setting, page 58*).
- Remove wireless sensors that you no longer use.

Turning On Battery Saver Mode

Battery saver mode allows you to adjust the settings to extend the battery life for longer rides.

1 Select  > **Battery Saver** > **Enable**.

2 Select an option:



- Select **Reduce Backlight** to reduce the backlight brightness.
- Select **Hide Map** to hide the map screen.
NOTE: When this option is enabled, navigation turn prompts still appear.
- Select **Satellite Systems** to change the satellite setting.

The estimated battery life remaining appears at the top of the screen.

After your ride, you should charge your device and disable battery saver mode to use all the device features.

My phone will not connect to the device

If your phone will not connect to the device, you can try these tips.

- Turn off your phone and your device, and turn them back on again.
- Enable Bluetooth technology on your phone.
- Update the Garmin Connect app to the latest version.
- Remove your device from the Garmin Connect app and the Bluetooth settings on your phone to retry the pairing process.
- If you bought a new phone, remove your device from the Garmin Connect app on the phone you intend to stop using.
- Bring your phone within 10 m (33 ft.) of the device.
- On your phone, open the Garmin Connect app, select  or , and select **Garmin Devices** > **Add Device** to enter pairing mode.
- Swipe down on the home screen to view the settings widget, and select **Phone** > **Pair Smartphone** to manually enter pairing mode.

Tips for Using the Edge 840 Solar Bike Computer

Solar charging is designed to optimize and extend the battery life of the device. Solar charging occurs even when the device is in sleep mode or turned off.

- When you are not using the device, point the display toward sunlight to extend the battery life.
- During an activity, scroll to the solar data page.

The solar data page highlights the intensity of the current light conditions and the accumulated ride time gained from the solar energy, taking into account the current usage and battery consumption of the device.

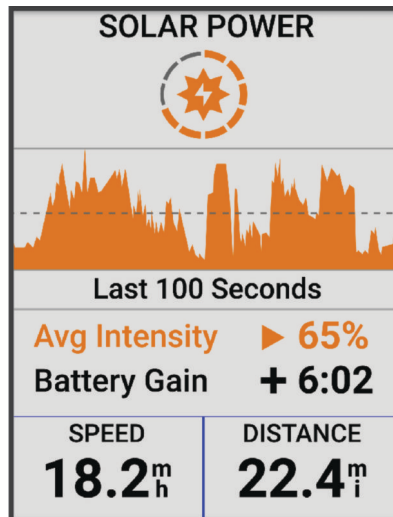

Improving GPS Satellite Reception

- Frequently sync the device to your Garmin account:
 - Connect your device to a computer using the USB cable and the Garmin Express application.
 - Sync your device to the Garmin Connect app using your Bluetooth enabled phone.
 - Connect your device to your Garmin account using a Wi-Fi wireless network.

While connected to your Garmin account, the device downloads several days of satellite data, allowing it to quickly locate satellite signals.



- Take your device outside to an open area away from tall buildings and trees.
- Remain stationary for a few minutes.

My device is in the wrong language

- 1 Select 
- 2 Scroll down to the second-to-last item in the list, and select it.
- 3 Scroll down to the seventh item in the list, and select it.
- 4 Select your language.

Setting Your Elevation

If you have accurate elevation data for your present location, you can manually calibrate the altimeter on your device.

- 1 Select **Navigation** >  > **Set Elevation**.
- 2 Enter the elevation, and select .

Temperature Readings

The device may display temperature readings that are higher than the actual air temperature if the device is placed in direct sunlight, held in your hand, or is charging with an external battery pack. Also, the device will take some time to adjust to significant changes in temperature.

Calibrating the Barometric Altimeter

Your device was already calibrated at the factory, and the device uses automatic calibration at your GPS starting point by default. You can manually calibrate the barometric altimeter if you know the correct elevation.

- 1 Select  > **System** > **Calibrate**.
- 2 Select an option:
 - To calibrate automatically from your GPS starting point, select **Auto Cal.**
 - To enter the current elevation manually, select **Calibrate** > **Enter Manually**.
 - To enter the current elevation from the digital elevation model (DEM), select **Calibrate** > **Use DEM**.
 - To enter the current elevation from your GPS starting point, select **Calibrate** > **Use GPS**.

Calibrating the Compass

NOTICE

Calibrate the electronic compass outdoors. To improve heading accuracy, do not stand near objects that influence magnetic fields, such as vehicles, buildings, and overhead power lines.

Your device was already calibrated at the factory, and the device uses automatic calibration by default. If you experience irregular compass behavior, for example, after moving long distances or after extreme temperature changes, you can manually calibrate the compass.

- 1 Select  > **System** > **Calibrate Compass**.
- 2 Follow the on-screen instructions.

Replacement O-rings

Replacement bands (O-rings) are available for the mounts.

NOTE: Use Ethylene Propylene Diene Monomer (EPDM) replacement bands only. Go to <http://buy.garmin.com>, or contact your Garmin dealer.

Getting More Information

- Go to support.garmin.com for additional manuals, articles, and software updates.
- Go to buy.garmin.com, or contact your Garmin dealer for information about optional accessories and replacement parts.

Appendix

Data Fields

NOTE: Not all data fields are available for all activity types. Some data fields require compatible accessories to display data. Some data fields appear in more than one category on the device.

TIP: You can also customize the data fields from the device settings in the Garmin Connect app.

Cadence Fields

Name	Description
Avg Cadence	Cycling. The average cadence for the current activity.
Cadence	Cycling. The number of revolutions of the crank arm. Your device must be connected to a cadence accessory for this data to appear.
Lap Cadence	Cycling. The average cadence for the current lap.

Cycling Dynamics Fields

Name	Description
Avg L. Peak Pwr Phase	The average power phase peak angle for the left leg for the current activity.
Avg Left Pwr Phase	The average power phase angle for the left leg for the current activity.
Avg PCO	The average platform center offset for the current activity.
Avg Right Pwr Phase	The average power phase angle for the right leg for the current activity.
Avg R. Peak Pwr Phase	The average power phase peak angle for the right leg for the current activity.
Lap L. Peak Pwr Phase	The average power phase peak angle for the left leg for the current lap.
Lap Left Pwr Phase	The average power phase angle for the left leg for the current lap.
Lap PCO	The average platform center offset for the current lap.
Lap R. Peak Pwr Phase	The average power phase peak angle for the right leg for the current lap.
Lap Right Pwr Phase	The average power phase angle for the right leg for the current lap.
Lap Time Seated	The time spent seated while pedaling for the current lap.
Lap Time Standing	The time spent standing while pedaling for the current lap.
Left Peak Pwr Phase	The current power phase peak angle for the left leg. Power phase peak is the angle range over which the rider produces the peak portion of the driving force.
Left Power Phase	The current power phase angle for the left leg. Power phase is the pedal stroke region where positive power is produced.
Platform Center Offset	The platform center offset. Platform center offset is the location on the pedal platform where force is applied.
Right Peak Pwr Phase	The current power phase peak angle for the right leg. Power phase peak is the angle range over which the rider produces the peak portion of the driving force.
Right Power Phase	The current power phase angle for the right leg. Power phase is the pedal stroke region where positive power is produced.
Time Seated	The time spent seated while pedaling for the current activity.

Name	Description
Time Standing	The time spent standing while pedaling for the current activity.

Distance Fields

Name	Description
Distance	The distance traveled for the current track or activity.
Lap Distance	The distance traveled for the current lap.
Last Lap Distance	The distance traveled for the last completed lap.
Distance Ahead	The distance ahead or behind the Virtual Partner.
Odometer	A running tally of distance traveled for all trips. This total does not clear when resetting the trip data.

eBike

Name	Description
Assist Mode	The current eBike assistance mode.
eBike Battery	The remaining battery power of an eBike.
Shifting Advice	The recommendation to shift up or down based on your current effort. Your eBike must be in manual shifting mode.
Travel Range	The estimated distance you can travel based on the current eBike settings and remaining battery power.
Smart Travel Range	The estimated remaining distance the eBike will provide assistance, taking into account the local terrain.

Elevation Fields

Name	Description
Ascent Remaining	During a workout or course, the remaining ascent when you are using an elevation target.
Asc. to Next Course Pt.	The remaining ascent to the next point on the course.
Elevation	The altitude of your current location above or below sea level.
Grade	The calculation of rise (elevation) over run (distance). For example, if for every 3 m (10 ft.) you climb you travel 60 m (200 ft.), the grade is 5%.
Total Ascent	The total elevation distance ascended since the last reset.
Total Descent	The total elevation distance descended since the last reset.
VAM	The average ascent velocity for the current activity.
30s VAM	The 30-second moving average of the average ascent velocity.
Avg VAM	The average ascent velocity for the current activity.
Lap VAM	The average ascent velocity for the current lap.

Gears

Name	Description
Di2 Battery Level	The remaining battery power of a Di2 sensor.
Di2 Shift Mode	The current shift mode of a Di2 sensor.
Front Gear	The front bike gear from a gear position sensor.
Gear Battery	The battery status of a gear position sensor.
Gear Combo	The current gear combination from a gear position sensor.
Gears	The front and rear bike gears from a gear position sensor.
Gear Ratio	The number of teeth on the front and rear bike gears, as detected by a gear position sensor.
Rear Gear	The rear bike gear from a gear position sensor.

Graphical

Name	Description
Cadence	Cycling. A color gauge showing your current cadence range.
Cadence Bars	A bar graph showing your current, average, and maximum cycling cadence values for the current activity.
Cadence Graph	A line graph showing your cycling cadence values for the current activity.
Elevation Graph	A line graph showing your current elevation, total ascent, and total descent for the current activity.
Heart Rate	A color gauge showing your current heart rate zone.
Heart Rate Bars	A bar graph showing your current, average, and maximum heart rate values for the current activity.
Heart Rate Graph	A line graph showing your current, average, and maximum heart rate values for the current activity.
Power	A color gauge showing your current power zone.
Power Bars	A bar graph showing your current, average, and maximum power output values for the current activity.
Power Graph	A line graph showing your current, average, and maximum power output values for the current activity.
Speed	A color gauge showing your current speed.
Speed Bars	A bar graph showing your current, average, and maximum speed values for the current activity.
Speed Graph	A line graph showing your speed for the current activity.

Heart Rate Fields

Name	Description
%Heart Rate Reserve	The percentage of heart rate reserve (maximum heart rate minus resting heart rate).
%Max Heart Rate	The percentage of maximum heart rate.
Aerobic Training Effect	The impact of the current activity on your aerobic fitness level.
Anaerobic Training Effect	The impact of the current activity on your anaerobic fitness level.
Avg %HRR	The average percentage of heart rate reserve (maximum heart rate minus resting heart rate) for the current activity.
Avg Heart Rate	The average heart rate for the current activity.
Avg %Max Heart Rate	The average percentage of maximum heart rate for the current activity.
Heart Rate	Your heart rate in beats per minute (bpm). Your device must have wrist-based heart rate or be connected to a compatible heart rate monitor.
Heart Rate Zone	The current range of your heart rate (1 to 5). The default zones are based on your user profile and maximum heart rate (220 minus your age).
HR Zone Graph	A line graph showing your current heart rate zone (1 to 5).
Lap %HRR	The average percentage of heart rate reserve (maximum heart rate minus resting heart rate) for the current lap.
Lap Heart Rate	The average heart rate for the current lap.
Lap %Max Heart Rate	The average percentage of maximum heart rate for the current lap.
Last Lap Heart Rate	The average heart rate for the last completed lap.
Load	The training load for the current activity. Training load is the amount of excess post-exercise oxygen consumption (EPOC), which indicates the strenuousness of your workout.
Respiration Rate	Your respiration rate in breaths per minute (brpm).
Time in Zone	The time elapsed in each heart rate or power zone.

Lights

Name	Description
Battery Status	The remaining battery power of a bike light accessory.
Beam Angle Status	The headlight beam mode.
Light Mode	The light network configuration mode.
Lights Connected	The number of connected lights.

MTB Performance

Name	Description
60s Flow	The 60-second moving average of the flow score.
60s Grit	The 60-second moving average of the grit score.
Flow	The measurement of how consistently you maintain speed and smoothness through turns in the current activity.
Grit	The measurement of difficulty for the current activity based on elevation, gradient, and rapid changes in direction.
Lap Flow	The overall flow score for the current lap.
Lap Grit	The overall grit score for the current lap.

Navigation Fields

Name	Description
Ascent Remaining	During a workout or course, the remaining ascent when you are using an elevation target.
Asc. to Next Course Pt.	The remaining ascent to the next point on the course.
Course Pt. Distance The remaining distance to the next point on the course.	The remaining distance to the next point on the course.
Destination Location	The position of your final destination.
Dist. to Point	The remaining distance to the next point.
Distance to Destination	The remaining distance to the final destination. You must be navigating for this data to appear.
Distance to Next	The remaining distance to the next waypoint on the route. You must be navigating for this data to appear.
ETA at Destination	The estimated time of day when you will reach the final destination (adjusted to the local time of the destination). You must be navigating for this data to appear.
ETA at Next	The estimated time of day when you will reach the next waypoint on the route (adjusted to the local time of the waypoint). You must be navigating for this data to appear.
Heading	The direction you are moving.
Next Waypoint	The next point on the route. You must be navigating for this data to appear.
Time to Destination	The estimated time remaining before you reach the destination. You must be navigating for this data to appear.
Time to Next	The estimated time remaining before you reach the next waypoint in the route. You must be navigating for this data to appear.
Time to Point	The remaining time to the next point.

Other Fields

Name	Description
Battery Level	The remaining battery power.
Calories	The amount of total calories burned.
GPS Signal Strength	The strength of the GPS satellite signal.
Laps	The number of laps completed for the current activity.
Performance Condition	The performance condition score is a real-time assessment of your ability to perform.
Sunrise	The time of sunrise based on your GPS position.
Sunset	The time of sunset based on your GPS position.
Temperature	The temperature of the air. Your body temperature affects the temperature sensor.
Time of Day	The time of day based on your current location and time settings (format, time zone, daylight saving time).
24-Hour Minimum Temperature	The minimum temperature recorded in the last 24 hours from a compatible temperature sensor.
24-Hour Maximum Temperature	The maximum temperature recorded in the last 24 hours from a compatible temperature sensor.

Power Fields

Name	Description
%FTP	The current power output as a percentage of functional threshold power.
3s Balance	The 3-second moving average of the left/right power balance.
3s Power	The 3-second moving average of power output.
3s Watts/kg	The 3-second moving average of power output in watts per kilogram.
10s Balance	The 10-second moving average of the left/right power balance.
10s Power	The 10-second moving average of power output.
10s Watts/kg	The 10-second moving average of power output in watts per kilogram.
30s Balance	The 30-second moving average of the left/right power balance.
30s Power	The 30-second moving average of power output.
30s Watts/kg	The 30-second moving average of power output in watts per kilogram.
Avg Balance	The average left/right power balance for the current activity.
Avg Power	The average power output for the current activity.
Avg Watts/kg	The average power output in watts per kilogram.
Balance	The current left/right power balance.
Intensity Factor	The Intensity Factor™ for the current activity.

Name	Description
Kilojoules	The accumulated work performed (power output) in kilojoules.
Lap Balance	The average left/right power balance for the current lap.
Lap NP	The average Normalized Power™ for the current lap.
Lap Power	The average power output for the current lap.
Last Lap NP	The average Normalized Power for the last completed lap.
Last Lap Power	The average power output for the last completed lap.
Lap Watts/kg	The average power output in watts per kilogram for the current lap.
Max. Lap Power	The top power output for the current lap.
Max. Power	The top power output for the current activity.
Normalized Power	The Normalized Power for the current activity.
Pedal Smoothness	The measurement of how evenly a rider is applying force to the pedals throughout each pedal stroke.
Power	Cycling. The current power output in watts.
Power Zone	The current range of power output (1 to 7) based on your FTP or custom settings.
Time in Zone	The time elapsed in each power zone.
Torque Effectiveness	The measurement of how efficiently a rider is pedaling.
TSS	The Training Stress Score™ for the current activity.
Watts/kg	The amount of power output in watts per kilogram.

Smart Trainer

Name	Description
Trainer Controls	During a workout, the resistance force applied by an indoor trainer.

Speed Fields

Name	Description
Avg Speed	The average speed for the current activity.
Lap Speed	The average speed for the current lap.
Last Lap Speed	The average speed for the last completed lap.
Max. Speed	The top speed for the current activity.
Speed	The current rate of travel.

Stamina Fields

Name	Description
Stamina	The current remaining stamina.
Estimated Distance	The current stamina distance remaining at the current effort.
Potential	The remaining potential stamina.
Estimated Time	The current stamina time remaining at the current effort.

Timer Fields

Name	Description
Avg Lap Time	The average lap time for the current activity.
Elapsed Time	The total time recorded. For example, if you start the activity timer and bike for 10 minutes, then stop the timer for 5 minutes, then start the timer and bike for 20 minutes, your elapsed time is 35 minutes.
Lap Time	The stopwatch time for the current lap.
Last Lap Time	The stopwatch time for the last completed lap.
Timer	The current time of the countdown timer.
Time Ahead	The time ahead or behind the Virtual Partner.
Segment Time	The amount of time racing the segment during the current activity.

Workouts

Name	Description
Calories to Go	During a workout, the remaining calories when you are using a calorie target.
Distance to Go	During a workout or course, the remaining distance when you are using a distance target.
Duration	The time remaining for the current workout step.
Heart Rate to Go	During a workout, the amount you are above or below the heart rate target.
Primary Target	During a workout, the target for the primary workout step.
Reps to Go	During a workout, the remaining repetitions.
Secondary Target	During a workout, the target for a secondary workout step.
Step Distance	During a workout, the distance for the current step.
Step Time	The time elapsed for the current workout step.
Time to Go	During a workout or course, the remaining time when you are using a time target.
Workout Comparison	A graph comparing your current effort to the workout target.
Workout Step	During a workout, the current step out of the total number of steps.

VO2 Max. Standard Ratings

These tables include standardized classifications for VO2 max. estimates by age and sex.

Males	Percentile	20–29	30–39	40–49	50–59	60–69	70–79
Superior	95	55.4	54	52.5	48.9	45.7	42.1
Excellent	80	51.1	48.3	46.4	43.4	39.5	36.7
Good	60	45.4	44	42.4	39.2	35.5	32.3
Fair	40	41.7	40.5	38.5	35.6	32.3	29.4
Poor	0–40	<41.7	<40.5	<38.5	<35.6	<32.3	<29.4

Females	Percentile	20–29	30–39	40–49	50–59	60–69	70–79
Superior	95	49.6	47.4	45.3	41.1	37.8	36.7
Excellent	80	43.9	42.4	39.7	36.7	33	30.9
Good	60	39.5	37.8	36.3	33	30	28.1
Fair	40	36.1	34.4	33	30.1	27.5	25.9
Poor	0–40	<36.1	<34.4	<33	<30.1	<27.5	<25.9

Data reprinted with permission from The Cooper Institute. For more information, go to www.CooperInstitute.org.

FTP Ratings

These tables include classifications for functional threshold power (FTP) estimates by sex.

Males	Watts per Kilogram (W/kg)
Superior	5.05 and greater
Excellent	From 3.93 to 5.04
Good	From 2.79 to 3.92
Fair	From 2.23 to 2.78
Untrained	Less than 2.23

Females	Watts per Kilogram (W/kg)
Superior	4.30 and greater
Excellent	From 3.33 to 4.29
Good	From 2.36 to 3.32
Fair	From 1.90 to 2.35
Untrained	Less than 1.90

FTP ratings are based on research by Hunter Allen and Andrew Coggan, PhD, *Training and Racing with a Power Meter* (Boulder, CO: VeloPress, 2010).

Heart Rate Zone Calculations

Zone	% of Maximum Heart Rate	Perceived Exertion	Benefits
1	50–60%	Relaxed, easy pace, rhythmic breathing	Beginning-level aerobic training, reduces stress
2	60–70%	Comfortable pace, slightly deeper breathing, conversation possible	Basic cardiovascular training, good recovery pace
3	70–80%	Moderate pace, more difficult to hold conversation	Improved aerobic capacity, optimal cardiovascular training
4	80–90%	Fast pace and a bit uncomfortable, breathing forceful	Improved anaerobic capacity and threshold, improved speed
5	90–100%	Sprinting pace, unsustainable for long period of time, labored breathing	Anaerobic and muscular endurance, increased power

Wheel Size and Circumference

Your speed sensor automatically detects your wheel size. If necessary, you can manually enter your wheel circumference in the speed sensor settings.

The tire size is marked on both sides of the tire. You can measure the circumference of your wheel or use one of the calculators available on the internet.

